



RI2000/3000/3300
SENSORLESS VECTOR TYPE
User Manual



Preface

Thank you for choosing the RI3000 frequency inverters.

RI3000 series vector control inverter is mainly positioned as a high-end market for OEM customers and the specific requirements of fan and pump load applications, its flexible design, both embedded SVC and VF control in one, can be widely used for speed control accuracy, torque response speed, low-frequency output characteristics and other situations with higher requirements.

This user manual supplies a detailed description of RI3000 series vector control inverter includes product characterization, structural features, parameter setting, operation and commissioning, inspection maintenance and other contents. Be sure to carefully read through the safety precautions before use, and use this product on the premise that personnel and equipment safety is ensured.

IMPORTANT NOTES

- To illustrate the details of the products, pictures in this manual based on products with outer casing or safety cover being removed. When using this product, please be sure to well install outer casing or covering by the rules, and operating in accordance with the manual contents;
- The illustrations this manual for illustration only and may vary with different products you have ordered;
- The company is committed to continuous improvement of products, product features will continue to upgrade, and the information provided is subject to change without notice.

Contents

Chapter 1 Safety Precautions

1.1 Safety Considerations	2
1.2 Use Considerations.....	9
1.3 Cautions for Inverter Disposal	11

Chapter 2 Product Description

2.1 Naming Rules.....	14
2.2 Nameplate.....	14
2.3 Series model.....	15
2.4 Technical Specification.....	16
2.5 Structure diagram	18
2.6 Dimensions.....	19
2.7 Optional Parts	23

Chapter 3 Installation and wiring

3.1 Mechanical Installation.....	28
3.2 Standard Wiring.....	29
3.3 Wiring with Single phase motor.....	38
3.4 EMC Installation Instruction.....	43

Chapter 4 Operation, Display and Application Examples

4.1 Initial Power on Operation	48
4.2 Running of Inverter.....	49
4.3 Introduction of the keypad.....	51
4.4 Control Panel Display State.....	54
4.5 Keyboard operation.....	56

Chapter 5 Function Parameter Table

5.1 Symbol Description	62
5.2 Function Code Table.....	62

Chapter 6 Function Code Description

(P0 Group) Basic running function parameter.....	84
(P1 Group) Frequency Setting Function Parameter.....	92
(P2 Group) Start/Brake Function Parameter.....	94
(P3 Group) Auxiliary Running Parameter.....	97
(P4 Group) Terminal Control Function Parameter.....	106
(P5 Group) Protection Function Parameter.....	121
(P6 Group) Fault Record Function Parameter.....	125
(P7 Group) Close Loop Running Control Function Parameter.....	126
(P8 Group) PLC Running Parameter.....	135
(P9 Group) Swing Frequency Function Parameter.....	139
(PA Group) Vector Control Parameter.....	144
(PF Group) Factory Function Paramete.....	146

Chapter 7 Troubleshooting

7.1 Fault Alarm and Troubleshooting.....	148
7.2 Fault Record Search.....	151
7.3 Fault Reset	151

Chapter 8 Preservation and Maintenance

8.1 Preservation and Maintenance.....	154
8.2 Periodic Preservation and Maintenance.....	154
8.3 Warranty of Inverter.....	155

Chapter 9 Serial Port Communication Protocol of Rs485

9.1 Communication Overview.....	158
9.2 Communication Protocol Specification.....	158
9.3 The ASCII Communication Protocol.....	159



Chapter 1

Safety Precautions





1.1 Safety Considerations	2
1.2 Use Considerations.....	9
1.3 Cautions for Inverter Disposal	11





Users are requested to read this chapter carefully when installing, commissioning and repairing this product and perform the operation according to safety precautions as set forth in this chapter without fail. We will bear no responsibility for any injury and loss as a result of any violation operation.







Safety signs in this manual

 DANGER	indicates the situation in which the failure to follow operating requirements may result in fire or serious personal injury or even death.
 CAUTION	indicates the situation in which the failure to follow operating requirements may cause moderate or slight injury and damage to equipment.

1.1 Safety Considerations

Use Stage	Safety Grade	Precautions
Before Installation	 DANGER	<ul style="list-style-type: none"> ◇ Do not install the product if the package is with water, or component is missing or broken; ◇ Do not install the product if the label on the package is not identical to that on the inverter.
	 CAUTION	<ul style="list-style-type: none"> ◇ Be careful of carrying or transportation. Risk of devices damage; ◇ Do not use damaged product or the inverters missing component .Risk of injury; ◇ Do not touch the parts of control system with bare hands. Risk of ESD hazard.
Installation	 DANGER	<ul style="list-style-type: none"> ◇ Installation base shall be metal or other non-flammable material. Risk of fire; ◇ Do not install inverter in an environment containing explosive gases, otherwise there is danger of explosion; ◇ Do not unscrew the fixing bolts, especially the bolts with red mark.
	 DANGER	<ul style="list-style-type: none"> ◇ Do not leave cable strips or screws in the inverter. Risk of inverter damage; ◇ Install the product at the place with less vibration and no direct sunlight;

Use Stage	Safety Grade	Precautions
Installation	 DANGER	<ul style="list-style-type: none"> ◇ Consider the installation space for cooling purpose when two or more inverters are placed in the same cabinet.
Wiring	 DANGER	<ul style="list-style-type: none"> ◇ Wiring must be performed by authorized and qualified personnel. Risk of danger; ◇ Circuit-breaker should be installed between inverter and the mains. Risk of fire; ◇ Make sure the input power supply has been completely disconnected before wiring. Failure to comply may result in personnel injury and/or equipment damage; ◇ Since overall leakage current of this equipment may be bigger than 3.5mA, for safety's sake, this equipment and its associated motor must be well grounded so as to avoid risk of electric shock; ◇ Never connect the power cables to the output terminals (U,V,W) of the AC drive. Pay attention to the marks of the wiring terminals and ensure correct wiring. Failure to comply will result in damage to the AC drive; ◇ Install braking resistors at terminals (P+)and (P- or PB) only. Failure to comply may result in equipment damage.
	 CAUTION	<ul style="list-style-type: none"> ◇ Since all adjustable frequency AC drives from Our company have been subjected to hi-pot test before delivery, users are prohibited from implementing such a test on this equipment. Failure to comply may result in equipment damage. ◇ Signal wires should to the best of the possibility be away from main power lines. If this cannot be ensured, vertical cross-arrangement shall be implemented, otherwise interference noise to control signal may occur. ◇ If motor cables are longer than 100m, it is recommended output AC reactor be used. Failure to comply may result in faults.
Before Power-on	 DANGER	<ul style="list-style-type: none"> ◇ Inverter shall be power-on only after the front cover is assembled. Risk of electrical hazard.
	 CAUTION	<ul style="list-style-type: none"> ◇ Verify that the input voltage is identical to the rated voltage of product, correct wiring of input terminals R,

Use Stage	Safety Grade	Precautions
Before Power-on	 CAUTION	S, T or L1, L2 and output terminals U, V, and W, wiring of inverter and its peripheral circuits, and all wires should be in good connection. Risk of inverter damage.
After Power-on	 DANGER	<ul style="list-style-type: none"> ◇ Do not open the cover after power. Risk of electrical hazard; ◇ Do not touches any input/output terminals of inverter with bare hands. Risk of electrical hazard.
	 CAUTION	<ul style="list-style-type: none"> ◇ If auto tuning is required, be careful of personal injury when motor is running. Risk of accident; ◇ Do not change the defaults of parameters. Risk of devices damage.
During Operation	 DANGER	<ul style="list-style-type: none"> ◇ Non-professionals shall not detect signals during operation. Risk of personal injury or device damage; ◇ Do not touch the fan or the discharging resistor to check the temperature. Failure to comply will result in personal burnt.
	 CAUTION	<ul style="list-style-type: none"> ◇ Prevent any foreign items from being left in the devices during operation. Risk of device damage; ◇ Do not control start/stop of inverter by ON/OFF of contactor. Risk of device damage.
Maintenance	 DANGER	<ul style="list-style-type: none"> ◇ Maintenance and inspection can only be performed by professionals. Risk of personal injury; ◇ Maintain and inspect devices after power is off. Risk of electric hazard; ◇ Repair or maintain the AC drive only ten minutes after the AC drive is powered off. This allows for the residual voltage in the capacitor to discharge to a safe value. Failure to comply will result in personal injury; ◇ All pluggable components can be inserted or pulled out only when power has been turned off; ◇ Set and check the parameters again after the AC drive is replaced.

1.2 Use Considerations

1.2.1 Motor Insulation Inspection

When the motor is used for the first time or when the motor is reused after being kept, or when periodical inspection is performed, insulation inspection shall be conducted with motor so as to avoid damaging the inverter because of the insulation failure of the motor windings. The motor wires must be disconnected from the inverter during the insulation inspection. It is recommended to use the 500V mega meter, and the insulating resistance measured shall be $5M\Omega$ at least.

1.2.2 Motor Thermal Protection

If the motor rating does not match that of the inverter, especially when the rated power of the inverter is higher than that of the motor, adjust motor protection parameters in the inverter or install thermal relay to protect motor.

1.2.3 Operating with the Frequency Higher than Grid Power Frequency

Output frequency of RI3000 is 0.00Hz~500Hz. If RI3000 is required to operate above 50.00Hz, please take the endurance of mechanical devices into consideration.

1.2.4 Mechanical Vibrations

Inverter may encounter mechanical resonance point of the load device at certain output frequencies which can be avoided by setting the skip frequency parameters of the inverter.

1.2.5 Motor Heat and Noise

Since output voltage of inverter is PWM wave and contains a certain amount of harmonics, so that the temperature, noise and vibration of the motor will be higher than those when the inverter runs at grid power frequency.

1.2.6 Voltage-sensitive device or capacitor on output side of the AC drive

Do not install the capacitor for improving power factor or lightning protection voltage-sensitive resistor on the output side of the AC drive because the output of the AC drive is PWM wave. Otherwise, the AC drive may suffer transient overcurrent or even be damaged.

1.2.7 Contactor at the I/O terminal of the AC drive

When a contactor is installed between the input side of the AC drive and the power supply, the AC drive must not be started or stopped by switching the contactor on or off. If the AC drive has to be operated by the contactor, ensure that the time interval between switching is at least one hour since frequent charge and discharge will shorten the service life of the capacitor inside the AC drive;

When a contactor is installed between the output side of the AC drive and the motor, do not turn off the contactor when the AC drive is active. Otherwise, modules inside the AC drive may be damaged.

1.2.8 Applied with the Rated Voltage

Apply RI3000 with the rated voltage. Failure to comply will damage inverter. If required, take a transformer to boost or step-down voltage.

1.2.9 Do Not Apply a 3-Phase Input Inverter to 2-Phase Input Applications

Do not apply a 3-phase input FR inverter to 2-phase input applications. Otherwise, it will result in faults or damage inverter.

1.2.10 Lightning Protection

RI3000 has integrated lightning over-current protection device which has certain self-protection capacity against the lightning. Additional protection devices have to be installed between inverter and power supply in the area where lightning occurs frequently.

1.2.11 Altitude De-rating

In places where the altitude is above 1000 m and the cooling effect reduces due to thin air, it is necessary to de-rate the AC drive. Contact Our company for technical support.

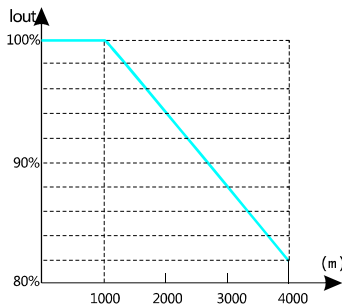

Figure 1-2 Inverter rated output current and elevation derating map

1.2.12 Some special usages

If wiring that is not described in this manual such as common DC bus is applied, contact the agent for technical support.

1.2.13 Adaptable Motor

The standard adaptable motor is adaptable four-pole squirrel-cage asynchronous induction motor or PMSM. For other types of motor, select a proper AC drive according to the rated motor current;

The cooling fan and rotor shaft of non-variable-frequency motor are coaxial, which results in reduced cooling effect when the rotational speed declines. If variable speed is required, add a more powerful fan or replace it with variable-frequency motor in applications where the motor overheats easily;

The standard parameters of the adaptable motor have been configured inside the AC drive. It is still necessary to perform motor auto-tuning or modify the default values based on actual conditions. Otherwise, the running result and protection performance will be affected;

The AC drive may alarm or even be damaged when short-circuit exists on cables or inside the motor. Therefore, perform insulation short-circuit test when the motor and cables are newly installed or during routine maintenance. During the test, make sure that the AC drive is disconnected from the tested parts.

1.3 Cautions for Inverter Disposal

The electrolytic capacitors on the main circuit and PCBA may explode when they are burnt. Emission of toxic gas may be generated when the plastic parts are burnt. Please dispose inverter as industrial wastes.

Chapter 2

Product Description

2.1 Naming Rules.....	14
2.2 Nameplate.....	14
2.3 Series model.....	15
2.4 Technical Specification.....	16
2.5 Structure diagram	18
2.6 Dimensions.....	19
2.7 Optional Parts	23

2.3 Series model

Model		Rated Capacity (KVA)	Rated output current(A)	Motor power (KW)
G	P			
RI 3000 series/Input voltage: 220V single phase				
RI3000-2S0004G	----	1.1	3.0	0.4
RI3000-2S0007G	----	1.5	4.7	0.75
RI3000-2S0015G	----	2.8	7.5	1.5
RI3000-2S0022G	----	3.8	10.0	2.2
RI 3000 series/Input voltage: 220V three-phase				
RI3000-2T0015G	----	3.0	7.0	1.5
RI3000-2T0022G	----	4.0	10.0	2.2
RI 3000 series/Input voltage: 380V three-phase				
RI3000-4T0007G	RI3000-4T0015P	1.5	2.5	0.75
RI3000-4T0015G	RI3000-4T0022P	2.2	4.0	1.5
RI3000-4T0022G	RI3000-4T0037P	3.0	6.0	2.2
RI3000-4T0037G	RI3000-4T0055P	5.9	9.6	3.7
RI3000-4T0055G	RI3000-4T0075P	8.5	14.0	5.5
RI3000-4T0075G	RI3000-4T0110P	11	17.0	7.5
RI3000-4T0110G	RI3000-4T0150P	17	25	11
RI3000-4T0150G	RI3000-4T0185P	21.7	32	15
RI3000-4T0185G	RI3000-4T0220P	25.7	39	18.5
RI3000-4T0220G	RI3000-4T0300P	29.6	45	22
RI3000-4T0300G	RI3000-4T0370P	39.5	60	30
RI3000-4T0370G	RI3000-4T0450P	49.4	75	37
RI3000-4T0450G	RI3000-4T0550P	60	91	45
RI3000-4T0550G	RI3000-4T0750P	73.7	112	55
RI3000-4T0750G	RI3000-4T0900P	99	150	75
RI3000-4T0900G	RI3000-4T1100P	116	176	90
RI3000-4T1100G	RI3000-4T1320P	138	210	110
RI3000-4T1320G	RI3000-4T1600P	167	253	132
RI3000-4T1600G	RI3000-4T1850P	200	304	160
RI3000-4T1850G	RI3000-4T2000P	234	355	185
RI3000-4T2000G	RI3000-4T2200P	248	380	200
RI3000-4T2200G	RI3000-4T2500P	280	426	220
RI3000-4T2500G	RI3000-4T2800P	318	470	250
RI3000-4T2800G	RI3000-4T3150P	342	540	280

Model		Rated Capacity (KVA)	Rated output current(A)	Motor power (KW)
G	P			
RI3000-4T3150G	RI3000-4T3500P	390	600	315
RI3000-4T3500G	RI3000-4T4000P	435	660	350
RI3000-4T4000G	RI3000-4T4500P	493	750	400
RI3000-4T4500G	RI3000-4T5000P	560	810	450
RI3000-4T5000G	RI3000-4T5600P	625	860	500
RI3000-4T5600G	RI3000-4T6300P	691	990	560
RI3000-4T6300G	RI3000-4T7100P	770	1100	630

2.4 Technical Specification

Items		Specifications
Input	Rated Voltage	Single phase 220V, three phase 200V, three phase 380V; 50Hz/60Hz
	Tolerance	Voltage: -20%~+20% voltage deviation ratio: <3% Frequency: ±5%
Output	Rated voltage	0~200V/220V/380V
	Frequency range	0Hz~500Hz
	Frequency resolution	0.01Hz
	Overload capability	150% rated current for 1 minute, 180% rated current for 3 seconds
Control function	Modulation modes	Optimized space voltage vector SVPWM modulation
	Control mode	Sensorless vector control (with optimal low frequency compensation)
	Frequency Accuracy	Digital setting: The highest frequency × ± 0.01% Analog setting: The highest frequency × ± 0.2%
	Frequency resolution	Digital setting: 0.01Hz; Analog setting: The highest frequency × 0.1%
	Start frequency	0.40Hz~20.00Hz
	Torque boost	Auto torque boost, manual torque boost 0.1%~30.0%
	V/F curve	Five ways: constant torque V/F curve, 1 kind of user defined V/F curve, 3 kinds of down torque curve (2.0/1.7/1.2 times the power)
	Acc./Dec. curve	Two ways: linear Acc./Dec., S-curve Acc./Dec.; 7 kinds of Acc./Dec. time, Time unit (minute/second) optional, max. time: 6000 minutes.
	DC braking	DC braking start frequency : 0~15.00Hz braking time : 0~60.0s braking current : 0~80%

Items		Specifications
Control function	Energy consuming braking	Below 22KW drive built-in energy consuming braking unit, external braking resistor is optional.
	Jog running	Jog frequency range:0.1Hz~50.00Hz, JOG Acc./Dec. time: 0.1~60.0s
	PI built-in	Easily constitute a close loop control system
	Multi-stage speed running	Multi-stage speed running available through built-in PLC or control terminals
	Textile swing frequency	Swing frequency available with preset and central frequency adjustable
	Auto voltage regulation	Keep a stable voltage automatically when the grid voltage transients
	Auto energy saving running	Saving energy by auto optimizing V/F curve according to the load
	Auto current limiting	Auto current limiting to prevent frequent over current fault trip
	Multi pumps control	With water supply kit, it can implement multi pumps constant pressure water supply
	Communication	Support: Modbus, Profibus, CANlink, CANopen
Running function	Running command channel	Keypad , Control terminal , Serial port , Above 3 channels are switchable
	Frequency setting channel	Keypad potentiometer setting: ▲、▼control panel keys setting; Function code setting: Serial port setting; Terminal up/down setting: Input Analog voltage setting: Input Analog current setting: Input pulse setting; Combination ways setting;Above ways are switchable.
	Switch input channel	FWD/REV command: 8channels programmable switch inputs, 35kinds of function can be set separately
	Analog input channel	4~20mA: 0-10V: 2 optional analog inputs
	Analog output channel	4~20mA or 0~10V optional, setting frequency and output frequency ,etc feature output
	Switch/pulse output channel	Programmable open collector output: relay output :0~20KHz pulse output:
Control panel	LEDdigital display	Display setting frequency, output voltage, output current, etc.
	External meter display	Display output frequency, output current, output voltage, etc.
	Key lock	All the keys can be locked
	Parameter copy	Function code parameters can be copied between inverters when use remote control panel.

Items		Specifications
Protection function		Overcurrent protection: overvoltage protection: undervoltage protection: overheating protection: overload protection, etc.
Optional parts		Braking unit: remote control panel: cable: panel mounting feet, etc.
Environment	Environment	Indoors, avoid from direct sunlight, dust, corrosive gas, oil mist, steam, water dropper salt, etc
	Altitude	Lower than 1000m (derating is necessary above 1000m)
	Ambient temperature	-10℃~+40℃
	Humidity	<95%RH, no condensation
	Vibration	Lower than 5.9m/s (0.6g)
	Storage temperature	-20℃~+60℃
Structure	Protection level	IP20 (In the selection of state display unit or the keyboard state)
	Cooling	Forced air cooling
Installation		Wall mounted; Floor mounted

2.5 Structure diagram

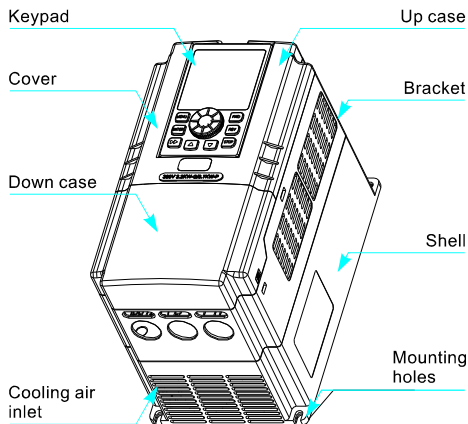

Figure 2-3 Product structure diagram

2.6 Dimensions

2.6.1 0.75~7.5KW

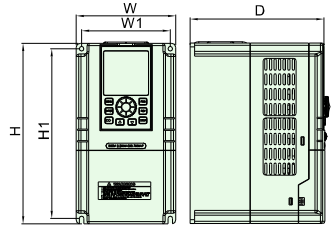

Figure 2-4

Model		Dimensions(mm)				Mounting dimensions(mm)		Pore size
G	P	H	W	D	H2	H1	W1	
RI 2000 series/Input voltage: 220V single phase								
RI2000-2S0004G	----	142	85	113	----	144	74	φ5
RI2000-2S0007G	----							
RI2000-2S0015G	----							
RI 2000 series/Input voltage: 380V three-phase								
RI2000-4T0007G	RI2000-4T0015P	142	85	113	----	144	74	φ5
RI2000-4T0015G	RI2000-4T0022P							
RI 3000D series/Input voltage: 220V single phase								
RI3000D-2S0022G	----	184	98	135	----	174	88	φ5
RI3000D-2S0037G	----							
RI 3000D series/Input voltage: 380V three-phase								
RI3000D-4T0007G	RI3000D-4T0015P	184	98	135	----	174	88	φ5
RI3000D-4T0015G	RI3000D-4T0022P							
RI3000D-4T0022G-M	RI3000D-4T0037P-M							
RI3000D-4T0022G	RI3000D-4T0037P	230	118	153	----	220	108	φ5
RI3000D-4T0037G	RI3000D-4T0055P							
RI3000D-4T0055G-M	RI3000D-4T0075P-M	230	118	173	----	220	108	φ5
RI3000D-4T0075G-M	RI3000D-4T00110P-M							
RI 3000 series/Input voltage: 220V single phase								
RI3000-2S0004G	----	142	85	113	----	144	74	φ5
RI3000-2S0007G	----							
RI3000-2S0015G	----							
RI3000-2S0022G	----	184	98	135	----	174	88	φ5

Model		Dimensions(mm)				Mounting dimensions(mm)		Pore size
G	P	H	W	D	H2	H1	W1	
RI 3000 series/Input voltage: 380V three-phase								
RI3000-4T0007G	RI3000-4T0015P	184	98	135	----	174	88	φ5
RI3000-4T0015G	RI3000-4T0022P							
RI3000-4T0022G	RI3000-4T0037P	230	118	153	----	220	108	φ5
RI3000-4T0037G	RI3000-4T0055P							
RI3000-4T0055G	RI3000-4T0075P	271	172	183	----	256	155	φ5
RI3000-4T0075G	RI3000-4T0110P							

2.6.2 11~110KW

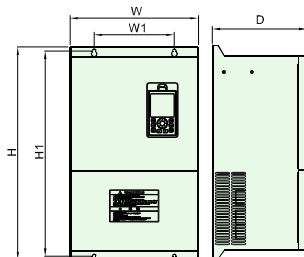

Figure 2-5

Model		Dimensions(mm)				Mounting dimensions(mm)		Pore size
G	P	H	W	D	H2	H1	W1	
RI 3000 series/Input voltage: 380V three-phase								
RI3000-4T0110G-M	RI3000-4T0150P-M	325	226	190	----	310	170	φ6
RI3000-4T0150G-M	RI3000-4T0185P-M							
RI3000-4T0110G	RI3000-4T0150P	360	248	210	----	347	170	φ6
RI3000-4T0150G	RI3000-4T0185P							
RI3000-4T0185G-M	RI3000-4T0220P-M	445	280	200	----	427	200	φ6
RI3000-4T0185G	RI3000-4T0220P							
RI3000-4T0220G	RI3000-4T0300P							
RI3000-4T0300G-M	RI3000-4T0370P-M	530	320	235	----	512	200	φ8
RI3000-4T0300G	RI3000-4T0370P							
RI3000-4T0370G	RI3000-4T0450P							

Model		Dimensions(mm)				Mounting dimensions(mm)		Pore size
G	P	H	W	D	H2	H1	W1	
RI 3000 series/Input voltage: 380V three-phase								
RI3000-4T0450G	RI3000-4T0550P	555	310	260	----	530	250	φ10
RI3000-4T0550G	RI3000-4T0750P							
RI3000-4T0750G	RI3000-4T0900P	650	400	300	----	620	280	φ14
RI3000-4T0900G	RI3000-4T1100P							
RI3000-4T1100G	RI3000-4T1320P							

2.6.3 132~400KW(Wall-mounted)

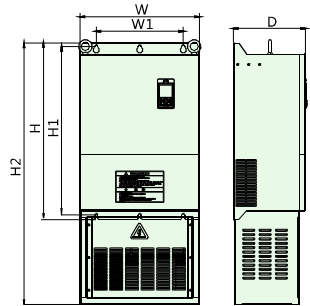

Figure 2-6

Model		Dimensions(mm)				Mounting dimensions(mm)		Pore size
G	P	H	W	D	H2	H1	W1	
RI 3000 series/Input voltage: 380V three-phase								
RI3000-4T1320G	RI3000-4T1600P	790	450	300	1080	756	280	φ14
RI3000-4T1600G	RI3000-4T1850P							
RI3000-4T1850G	RI3000-4T2000P	810	550	330	1150	776	280	φ14
RI3000-4T2000G	RI3000-4T2200P							
RI3000-4T2200G	RI3000-4T2500P	810	640	350	1270	776	480	φ14
RI3000-4T2500G	RI3000-4T2800P							
RI3000-4T2800G	RI3000-4T3150G	1200	720	372	1576	1150	500	φ14
RI3000-4T3150G	RI3000-4T3500G							
RI3000-4T3500G	RI3000-4T4000P	1270	820	400	1760	1220	600	φ14
RI3000-4T4000G	RI3000-4T4500P							

2.6.4 280~315KW

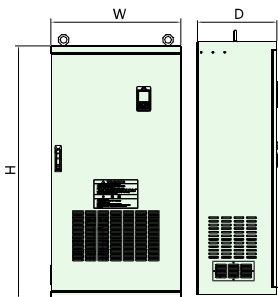

Figure 2-7

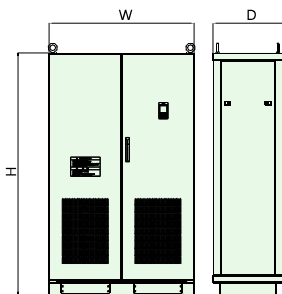

Figure 2-8

Model		Dimensions(mm)		
G	P	H	W	D
RI 3000 series/Input voltage: 380V three-phase				
RI3000-4T2800G	RI3000-4T3150P	1440	720	440
RI3000-4T3150G	RI3000-4T3500P			

2.6.5 350~630KW

Model		Dimensions(mm)		
G	P	H	W	D
RI 3000 series/Input voltage: 380V three-phase				
RI3000-4T3500G	RI3000-4T4000P	1700	950	475
RI3000-4T4000G	RI3000-4T4500P			
RI3000-4T4500G	RI3000-4T5000P	1900	950	475
RI3000-4T5000G	RI3000-4T5600P			
RI3000-4T5600G	RI3000-4T6300P	2000	1200	600
RI3000-4T6300G	RI3000-4T7100P			

2.7 Optional Parts

The following parts are optional. If require, please order.

2.7.1 Remote control panel

Part name	model	Features	Description
Remote control pane	RI3000-YK01 (No LCD liquid crystal display)	1. Control slave inverter to run, stop, jog run, fault reset, change setting frequency, change function parameters and running direction.	1. RS485 communications applied between remote control panel and inverter which are connected by a 4-core cable via RJ45 network port. 2. The maximum connection distance is 500M. The inverter supports local control panel and remote control panel used at the same time, no priority. Both can control the inverter. Hot plug in for remote control
	RI3000-YK02 (Have LCD liquid crystal display)	2. Monitor slave inverter's running frequency, setting frequency , output voltage, output current, bus bar voltage, etc.	

2.7.2 Communication cable

Part name	model	Features	Description
Communication cable for remote control panel	RI3000-LAN0020 (2.0m)	Used to remotely operate the keyboard and the drive host connection.	Standard options:1m, 2m, 5m, 10m, 20m. Which is more than 20m can be customized for the remote keyboard and inverter connection.

2.7.3 Field bus Adaptor

Part name	Features	Description
Communication cable for remote control panel	The inverter can be connected into MODBUS field bus network via adaptor as a slave station in the network.	Please refer to Chapter 9 for communication protocol.

Part name	Features	Description
Communication cable for remote control panel	The function as follow: ❏ Send command to inverter such as start, stop, jog running, etc; ❏ Send speed or frequency signal to inverter; ❏ Read status from inverter; ❏ Fault reset for the inverter.	Please refer to Chapter 9 for communication protocol.

2.7.4 Braking Resistors

RI3000 series inverters under 22KW have built-in braking units. If energy consuming braking is needed, please choose braking resistors according to Table 2-3. The wire connections of braking resistors are shown in Figure 2-9.

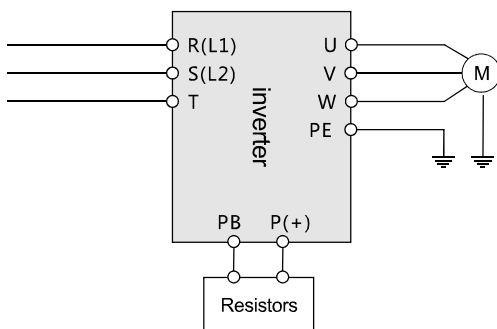

Figure 2-10 The wire connection of braking resistors

Table 2-1 Braking resistors selection table

Model	Applicable motor (KW)	Resistance(Ω)	Resistance power	Brake unit
220V single phase				
RI3000-2S0004G	0.4KW	200 Ω	100W	Built-in
RI3000-2S0007G	0.75KW	150 Ω	200W	Built-in
RI3000-2S0015G	1.5KW	100 Ω	400W	Built-in
RI3000-2S0022G	2.2KW	75 Ω	500W	Built-in
380V three-phase				
RI3000-4T0007G	0.75KW	300 Ω	400W	Built-in

Model	Applicable motor (KW)	Resistance(Ω)	Resistance power	Brake unit
RI3000-4T0015G	1.5KW	300 Ω	400W	Built-in
RI3000-4T0022G	2.2KW	200 Ω	500W	Built-in
RI3000-4T0037G	3.7KW	200 Ω	500W	Built-in
RI3000-4T0055G	5.5KW	100 Ω	800W	Built-in
RI3000-4T0075G	7.5KW	75 Ω	800W	Built-in
RI3000-4T0110G	11KW	50 Ω	1KW	Built-in
RI3000-4T0150G	15KW	40 Ω	1.5KW	Built-in
RI3000-4T0185G	18.5KW	30 Ω	4KW	Built-in
RI3000-4T0220G	22KW	30 Ω	4KW	Built-in
RI3000-4T0300G	30KW	20 Ω	6KW	Built-in
RI3000-4T0370G	37KW	16 Ω	9KW	Built-in
RI3000-4T0450G	45KW	13.6 Ω	9KW	External
RI3000-4T0550G	55KW	20 Ω *2	12KW	External
RI3000-4T0750G	75KW	13.6 Ω *2	18KW	External
RI3000-4T0900G	90KW	20 Ω *3	18KW	External
RI3000-4T1100G	110KW	20 Ω *3	18KW	External

Chapter 3

Installation and wiring

3.1 Installation	28
3.2 Removing and Mounting Front Cover of Inverter.....	29
3.3 Wiring with Single phase motor.....	38
3.4 EMC Installation Instruction.....	43

3.1 Mechanical Installation

3.1.1 Installation Environment

- Please mount inside a well-ventilated location. The ambient temperature is required to be within the range of -10~40°. If the temperature is higher than 40°, the inverter should be de-rated, at the same time the ventilation and heat dissipation should be enhanced.
- Be away from the location full of dust or metal powder, and mount in the location free of direct sunlight.
- Mount in the location free of corrosive gas or combustible gas.
- Humidity should be lower than 90% with no dew condensation.
- Mount in the location where vibration is less than 5.9m/s² (0.6G) .
- Please try to keep the inverter away from EMI source and other electronic devices which are sensitive to EMI.

3.1.2 Mounting Space and Direction

- Generally in vertical way.
- For the requirements on mounting space and distance, refer to Fig.3-1.
- When several inverters are installed in one cabinet, they should be mounted in parallel with special incoming and out coming ventilation and special fans. When two inverters are mounted up and down, an air flow diverting plate should be fixed as shown in Fig.3-2 to ensure good heat dissipation.

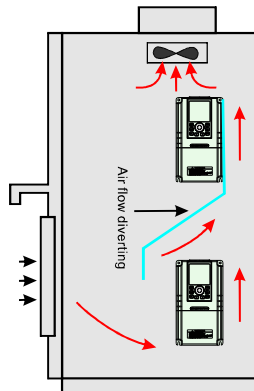
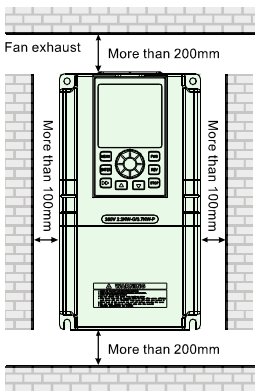

Figure 3-1 Mounting space and distance Figure 3-2 Mounting of multiple inverters

3.2 Standard Wiring

3.2.1 Wiring precautions



DANGER

- Before wiring, please ensure the power has been removed and be waited for at least 10minutes;
- Please do not connect AC power to output terminals U/V/W;
- To ensure the safety, the inverter and motor should be safety grounding. It is necessary to use copper wire above 3.5mmas ground wire, grounding resistance less than 10Ω ;
- The inverter has gone through voltage withstand test in factory, please do not make it again;
- Solenoid switch or absorbing devices, such as ICEL, is prohibited to connect inverter output;
- To provide input over current protection and for convenience in maintenance, the inverter should be connected to AC power through circuit breaker;
- Please use twisted wire or shielded wire above 0.75mm for the wiring of relay input/output loop(X1~X6, FWD, REV, OC, DO).One end of shielding layer suspended, and the other side connected to PE grounding terminal of inverter, wiring length less than 50m .



CAUTION

- The cover can be removed only when the power is switched off, all the LED on the panel are off and waiting at least for 10 minutes;
- Wiring work can be performed only when the DC voltage between P+ and P- terminals is lower than 36V;
- Wiring work can only be done by trained or professional personnel;
- Before usage, check whether the mains voltage meets the requirement of inverter input voltage.

3.2.2 Main Circuit Wiring

3.2.2.1 Main circuit wiring diagram

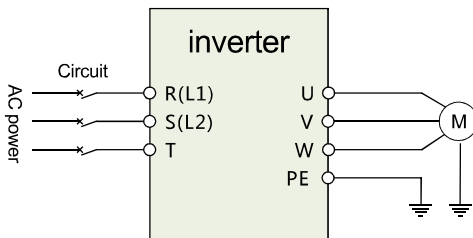

Figure 3-3 Main circuit wiring

3.2.2.2 Main Circuit Terminals Diagram

Apply to	Main circuit terminal	Terminal name	Function
220V 1-phase 0.4KW~2.2KW		L1, L2	220V 1-phase Input terminals
		U, V, W	3-phase Output terminals
		E	Earthing
380V 3-phase 0.75KW~1.5KW		R, S, T	380V 3-phase Input terminals
		U, V, W	380V 3-phase Output terminals
		P+, PB	Braking resistor wiring terminals
380V 3-phase 2.2KW~3.7KW		R, S, T	380V 3-phase Input terminals
		U, V, W	380V 3-phase Output terminals
		P+, PB	Braking resistor wiring terminals
380V 3-phase 5.5KW~22KW		R, S, T	380V 3-phase Input terminals
		U, V, W	380V 3-phase Output terminals
		P+, PB	Braking resistor wiring terminals
380V 3-phase 30KW~630KW		R, S, T	380V 3-phase Input terminals
		U, V, W	380V 3-phase Output terminals
		P+, P-	Braking resistor wiring terminals

Table 3-1 Description of Main Circuit input/output terminals

3.2.3 Basic Wiring Diagram

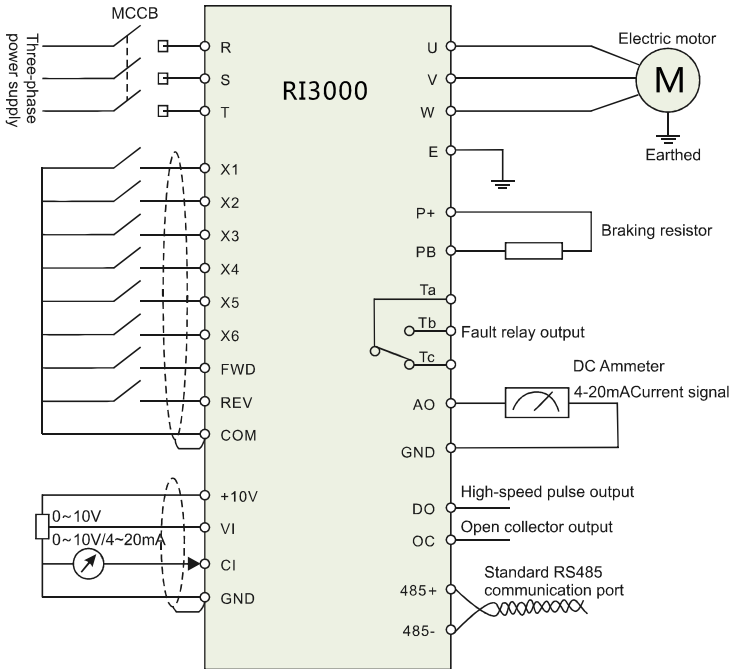

Figure 3-4 Basic Wiring Diagram

3.2.4 Control Circuit Terminal Wiring

3.2.4.1 Position and Function of Terminals and Jumpers on Control Circuit

using the inverter, Please make correct terminals wiring and jumpers setting. It is suggested to use above 1mm² wire as terminal connection wire.

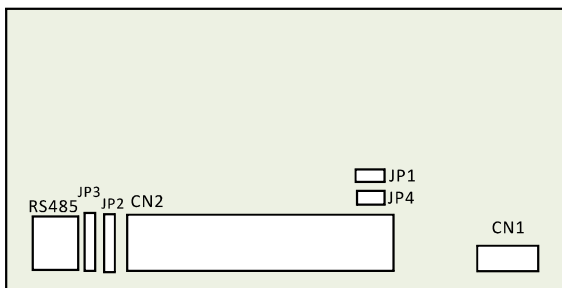

Figure 3-5 Position of terminals and jumpers on control

3.2.4.2 Jumper switch

NO	Function	Setting	FD
JR1	Pulse output terminal DO power selection	1-2 connected: internal 24V power of inverter 2-3 connected: external power	external power
JR2	Analog output terminal current/voltage output selection	1-2: 0~10V: AO1 output voltage signal 2-3: 4~20mA: AO1 output current signal	0~10V
JR3	0~10V Terminal CI current/voltage Input selection	1-2: V side, 0~10 V voltage signal 2-3: I side, 4~20 mA current signal	0~10V
JR4	X6 terminal input mode selection	1-2: PLC side, X6 used as multifunctional terminal 2-3: FCH side: X6 used as an external pulse input	PLC side

Table 3-2 Jumper switch function

3.2.4.3 Function of CN 1 terminal

Sort	Terminal	Name	Function Description	Specification
Relay output terminal	TA/RA	Multi functional relay output terminal	Can be defined as multifunctional Relay output terminal by programming, refer to Chapter 6.5 P4.12, P4.13	TA-TC: NC
	TB/RB			TA-TB: Normally open contact capacity AC250V/2A (COSΦ=1)
	TC/RC			AC250V/1A (COSΦ=0.4) DC30V/1A

Table 3-3 CN 1 terminal function

3.2.4.4 Function of CN 2 terminal

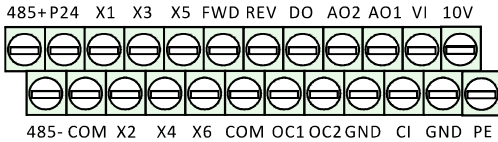

Figure 3-6 CN2 terminal order

Sort	Terminal	Name	Function Description	Specification
Communication	485+	Rs485 communication port	Rs485 differential signal positive terminal	Twisted or shielded wire needed
	485-		Rs485 differential signal negative terminal	
Multifunctional output terminal	OC1	Open collector output terminal 1	Can be defined as multifunctional on-off output terminal by programming, refer to Chapter 6.5P4.10 (Common port: COM)	Couple isolated output Working voltage: 9~30V Max.outputcurrent:50mA
	OC2	Open collector output terminal 2	Can be defined as multifunctional on-off output terminal by programming, refer to Chapter 6.5P4.11 (Common port: COM)	Couple isolated output Working voltage: 9~30V Max.outputcurrent:50mA
Pulse output terminal	DO	Open collector pulse Output terminal	Can be defined as multifunctional Pulse output terminal by programming, Refer to Chapter 6.5P4.21/P4.22 (Common port: COM)	Max. output frequency: 20KHz output freq range defined by P4.21
Analog input	VI	Analog input VI	Analog voltage input (Grounding: GND)	Input voltage range:0~10V (input resistance:10KΩ) Resolution: 1/1000
	CI	Analog input CI	Analog voltage/current input, Choose voltage or current input by Setting JP3 jumper. Factory default: voltage input(Grounding: GND)	Inputvoltage range:0~10V (input resistance:10KΩ) Inputcurrentrange:0~20mA (input resistance:500Ω) Resolution: 1/1000

Sort	Terminal	Name	Function Description	Specification
Analog output	AO1	Analog output AO1	Analog voltage/current output, indicating 7 quantities, choose Voltage or current output by setting JP2 jumper. Factory default: voltage output (Grounding: GND)	Current output range: 4~20mA Voltage output range: 0~10V
	AO2	Analog output AO2	Analog voltage output, indicating 7 quantities (Grounding: GND)	Voltage output range: 0~10V
Running	FWD	Forward	Refer to chapter 6.5 P4.08	Couple isolated input Input resistance: 2KΩ
	REV	Reverse		
Multifunctional input terminal	X2	Multifunctional input terminal 2	Refer to chapter 6.5 P4.08	input frequency: 200Hz Input voltage range: 9~30V X1~X4 FWD、REV COM 
	X3	Multifunctional input terminal 3		
	X4	Multifunctional input terminal 4		
	X5	Multifunctional input terminal 5		
	X6	Multifunctional input terminal 6		
Power source	P24	+24V power source	Supply +24V power (negative terminal: COM)	
	10V	+10V power source	Supply +10V power (negative terminal: GND)	Max. output current: 50mA
	GND	+10V common port	Grounding of analog signal and +10V power source	Terminal COM and GND are isolated inside
	COM	+24V common port	Digital signal input, output common port	

Table 3-4 CN 2 terminal function

3.2.5 Analog Input/Output Terminal Wiring

① Analog voltage signal input through VI terminal as follow wiring :

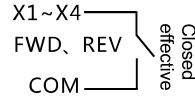
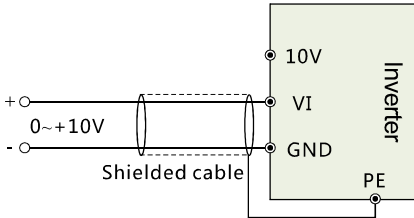

Figure 3-7 VI terminal wiring

② Analog signal input through CI terminal, jumper selection for input voltage (0~10V) or input current (4~20mA) as follow wiring :

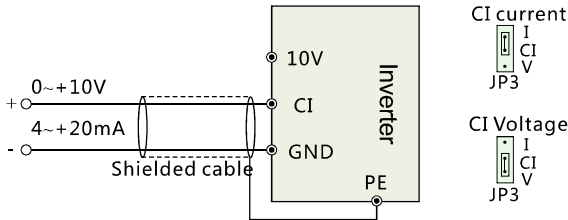

Figure 3-8 CI terminal wiring

③ Analog output terminal AO wiring

Analog output terminal can be connected with external analog meter indicating various physical quantity, jumper selection for output voltage (0~10V) or output current (4~20mA) as follow wiring.

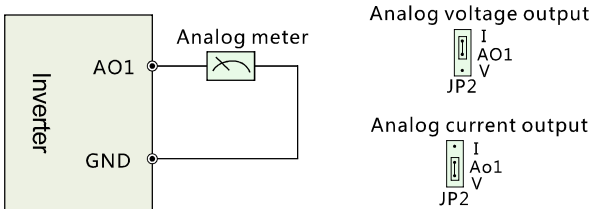

Figure 3-9 Analog output terminal wiring

NOTES:

- Filter capacitor or common-mode inductor can be installed between VI And GND terminal or CI and GND terminal when using analog input mode.
- Please use shielded cable and do well grounding , keep the wire as short as possible in order to prevent external interference when using analog input/output mode.

3.2.6 Communication Terminal Wiring

The inverter supplies standard RS 485 communication port .

It can constitute one master one slave control system or a one master multi slaves system. The upper computer(PC/PLC)can real time monitor the inverter in the control system and achieve complicated control function such as remote control and spermatic, etc.

➤ Remote control panel can be connected with inverter viaRS485port by plugging in the remote control panel into RS485 port without any parameter setting. The local control panel of inverter and remote control panel can work at the same time.

➤ Inverter RS 485 port and upper computer wiring as follow :

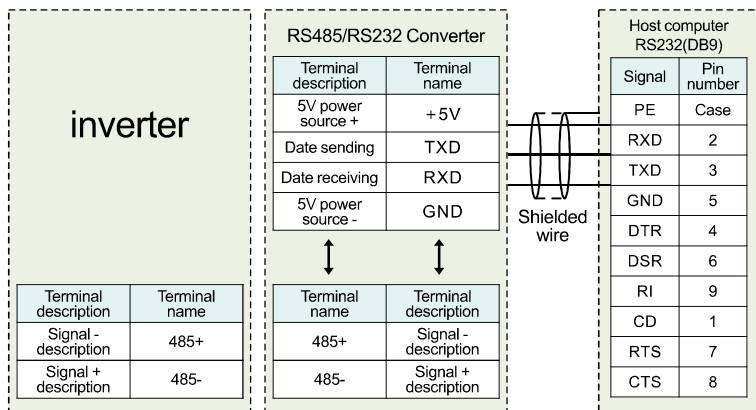

Figure 3-10 RS485-(RS485/232)-RS232 communication wiring

➤ Multi inverters can communicate via RS485, controlled by PC/PLC as a Master shown as Fig.3-11. It also can be controlled by one of inverters as a Master shown as Fig.3-12.

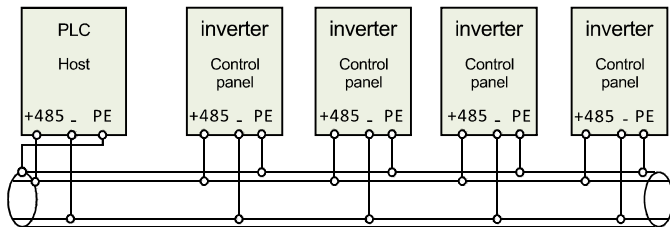

Figure 3-11 PLC communication with multi inverters

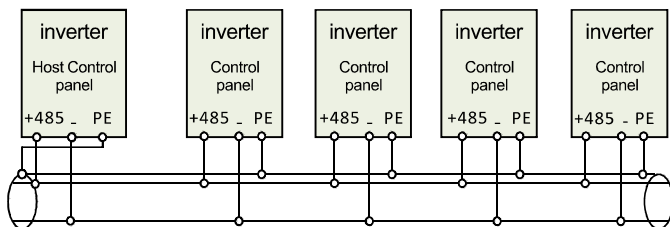

Figure 3-12 Multi inverters communication

The more inverters connected, the more the communication interference may occur. Please make wiring as above and do well grounding for inverters and motors, or adopt the following measures to prevent interference as even above wiring can't work.

- ❶ Separately power supply to PC/PLC or isolated the power of PC/PLC;
- ❷ Use EMIFIL to the wire or reduce carrier frequency properly.

3.3 Wiring with Single phase motor

3.3.1 Single phase motor introduction

Single phase motor generally means asynchronous single phase motor powered by single phase AC 220V, there're two phase winding in motor stator and motor rotor is common squirrel cage. The distribution of two phase winding and different power supply will lead to different starting characteristics and operating characteristics

Usually single phase motor is with single capacitor or double capacitor, photos of motor are as below:

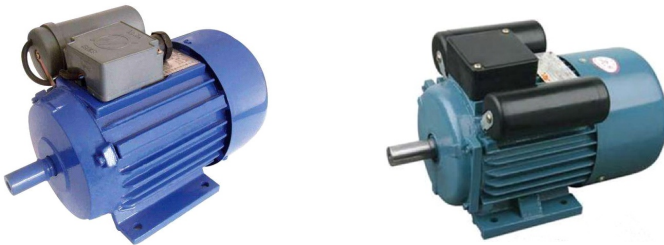

Figure 3-13 Motor with single capacitor and double capacitor

Single phase motor is consisted of main winding, secondary winding, capacitor and centrifugal switch, internal wiring of single phase motor with single capacitor is as below:

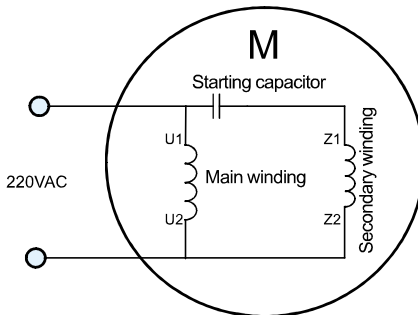

Figure 3-14 Operation mode: Internal wiring of motor with single capacitor

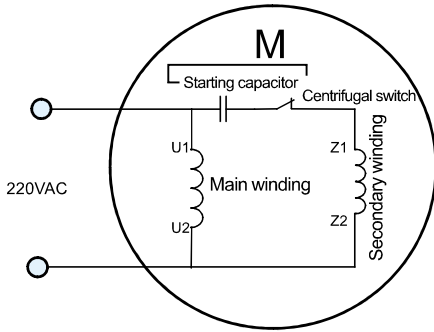

Figure 3-15 Starting mode: Internal wiring of motor with single capacitor

Internal wiring of single phase motor with double capacitors is as below:

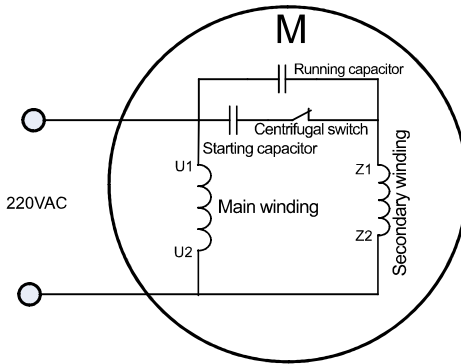

Figure 3-16 Internal wiring of motor with double capacitors

Resistor starting mode single phase motor, and internal wiring is as below:

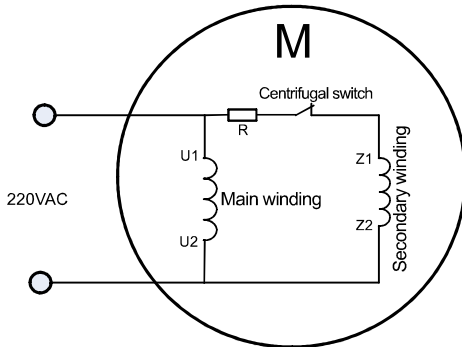

Figure 3-17 Resistor starting mode: Internal wiring of motor

After removing the capacitors from above motors, remain 4 main and secondary winding terminals as below:

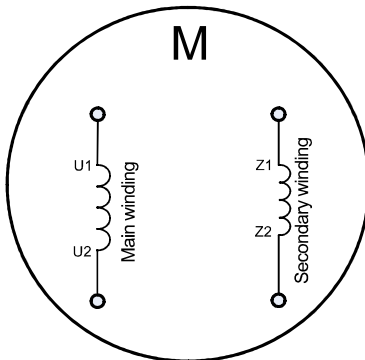

Figure 3-18 Main and secondary winding of motor (After removing the capacitors)

3.3.2 Wiring between VFD and motor (Capacitor removable)

Connect main and secondary winding of motor to inverter UVW, then inverter can work. But due to the motor winding difference, motor forward wiring must be as below, if not cause motor too heat.

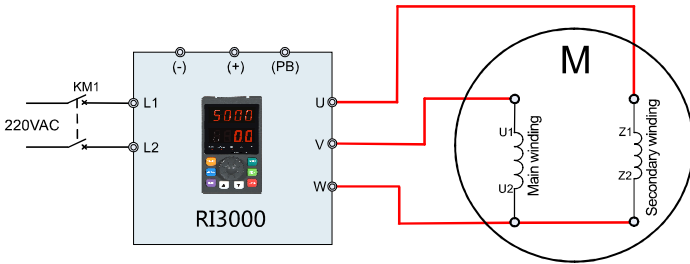

Figure 3-19 Forward wiring between RI3000 (<=0.75Kw) and motor

Motor reverse can't be completed through parameter setting of inverter or change any two phase wirings, motor reverse wiring must be as below:

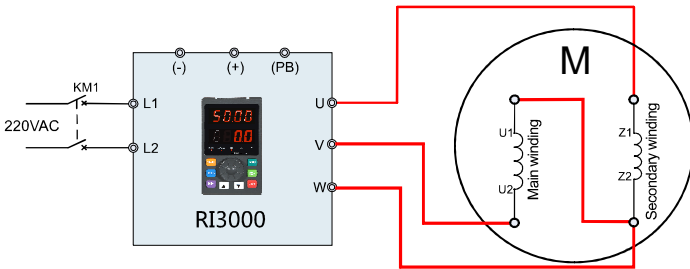

Figure 3-20 Reverse wiring between RI3000 (<=0.75Kw) and motor

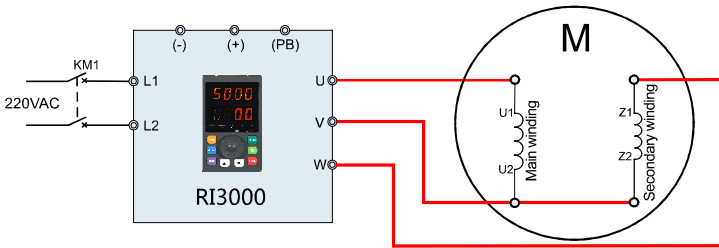

Figure 3-21 Forward wiring between RI3000 (> 0.75kW) and motor

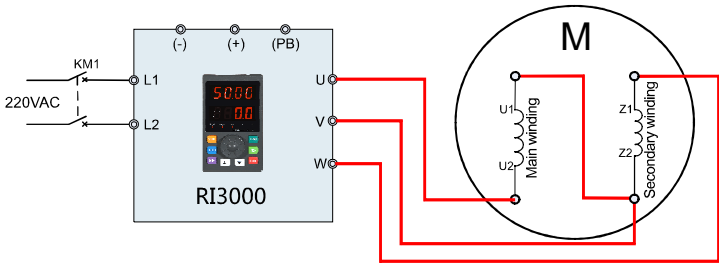

Figure 3-22 Reverse wiring between RI3000 (> 0.75kW) and motor

Note: After wiring completed, need to set P9.13=1(Thousand's digit).

3.3.3 Wiring between VFD and motor (Non-removable capacitor)

If the capacitor in motor is Non-removable, the wiring is as below. The forward and reverse is determined by VW wiring sequence.

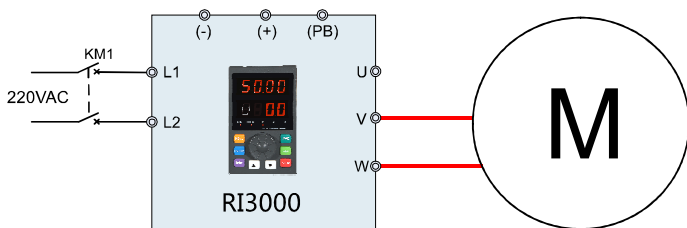

Figure 3-23 Wiring between RI3000 ($\leq 0.75\text{Kw}$) and motor

The forward and reverse is determined by UV wiring sequence.

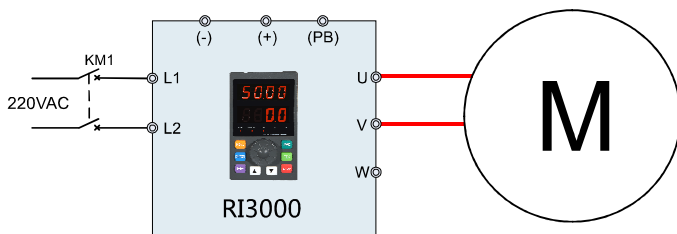

Figure 3-24 Wiring between RI3000 ($\leq 0.75\text{Kw}$) and motor

Note: After wiring completed, need to set P9.13=2(Thousand's digit)

3.4 EMC Installation Instruction

Inverter outputs PWM wave, it will produce electromagnetic noise. To reduce the interference, EMC installation will be introduced in this section from noise suppression, wire connection, grounding, leakage current and filter of power supply.

3.4.1 Noise Suppression

3.4.1.1 Noise Type

Noise is unavoidable during inverter operation. Its influence over peripheral equipment is related to the noise type, transmission means, as well as the design, install action, wiring and grounding of the driving system.

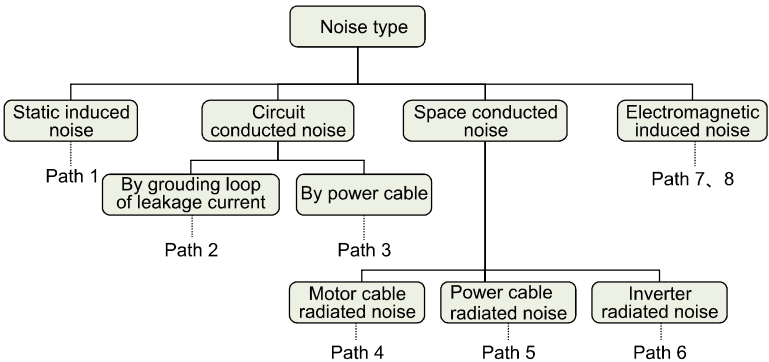

Figure 3-13 Noise classification

3.4.1.2 Noise Suppression Methods

Path	Noise suppression methods
Path 2	<ul style="list-style-type: none"> ◇ If a closed loop is formed between the peripheral equipment and the inverter wiring, the grounding leakage of the inverter will misoperate the equipment. Solution: Remove the grounding of the peripheral equipment.
Path 3	<ul style="list-style-type: none"> ◇ When peripheral equipment share the same power source with the inverter, the noise transmitted through the power line may misoperate the peripheral equipment. Solution: Mount a noise filter at inverter input side or isolate the peripheral equipment with an isolated transformer or power filter.
Path 4 Path 5 Path 6	<ul style="list-style-type: none"> ◇ Electronic equipment such as computers, measuring meters, sensors and radio equipment, when in the same cabinet with inverter, with their wiring close to the inverter, may misoperate due to radio interference. Solution:

Path	Noise suppression methods
Path 4 Path 5 Path 6	<ul style="list-style-type: none"> ◇ The susceptible equipment and its signal lines should be kept away from the inverter. Use shielded cable for the signal line. Ground the shielding coat. Protect the signal cable with a metal pipe and keep it off the inverter input/output cable. When crossing of the signal line and the inverter input/output cables is inevitable, make sure it is orthogonal. ◇ Mount radio noise filter or linear noise filter (choke coil) to the input/output side of the inverter to suppress the radio noise. ◇ The shielding coat for the cable connecting inverter and the motor should be thick. The wiring can be arranged through thick pipe (2mm or thicker) or cement trench. The cable should be through a metal pipe, and has its shielding coat grounded. You may use the 4-core cable as the motor power cable. Ground one core at inverter side with the other end of it connected to the motor case.
Path 1 Path 7 Path 8	<ul style="list-style-type: none"> ◇ When the signal cables are parallel to, or bound together with the power cables, the static and electromagnetic induction will cause the noise transmit through the signal cable, misoperating the related equipment. Solution: ◇ Avoid laying the signal cables parallel to the power cable, or bind them together; ◇ Keep the susceptible peripheral equipment away from the inverter; ◇ Keep the susceptible signal cables away from the input/output cables of inverter. Shielded cables should be used as the signal or power cable. Lead them through metal pipes respectively would achieve better effect. The metal pipes should be at least 20cm away from each other.

Table 3-5 Noise suppression method

3.4.2 Wiring Connection and Grounding

- ① Please do not to wire motor cable (from inverter to motor) in parallel with power cable and keep at least 30cm from each other;
- ② Please try to arrange the motor cable through Control signal cable metal pipe or in metal wiring groove;
- ③ Please use shielded cables control signal cable, and connect the shielding coat to PE terminal of inverter with proximal grounding to inverter;
- ④ PE grounding cable should be directly connected to the earth plate;
- ⑤ The control signal cable shouldn't be in parallel with strong electricity cable- (power cable/motor cable). They should not be bent together and should be

kept away as least 20cm from each other. If cable crossing is inevitable, please make sure it is same as Fig.3-1 6;

- ⑥ Please ground the control signal cable separately with power cable/motor cable;
- ⑦ Please don't connect other devices to inverter power input terminals(R/S/T).

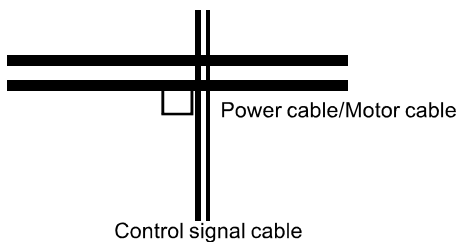

Figure 3-14 System wiring requirements

Chapter 4

Operation, Display and Application Examples

4.1 Initial Power on Operation	42
4.2 Running of Inverter.....	43
4.3 Introduction of the keypad.....	45
4.4 Control Panel Display State.....	48
4.5 Keyboard operation.....	50

4.1 Initial Power on Operation

After inspecting cable connection and power source for sure, switch on inverter input AC power switch. The inverter's LED on control panel will display dynamic start menu. When it displays set frequency, it means initialization has been completed :

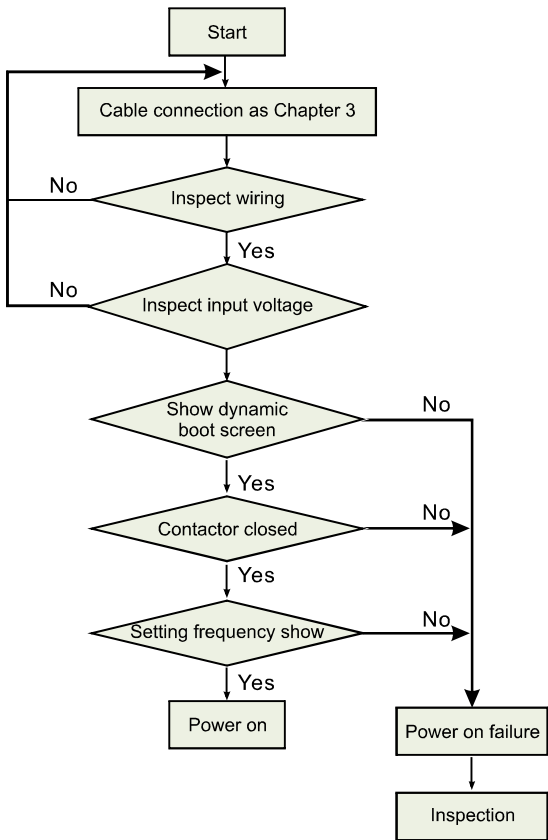

Figure 4-1 Inverter first power applied operation

Chapter 4

4.2 Running of Inverter

4.2.1 Running Command Channels





Channel	Control method
Control panel	Use     Keys on the panel to control the inverter. (Factory default)
Control terminal	Use terminal FWD,REV, COM to constitute a 2-wire control mode, or use one of terminals among X1~X6 and FWD, REV to constitute a 3-wire control mode.
Serial port	<ul style="list-style-type: none"> ☒ Use upper computer (PC/PLC) or Master inverter to control Slave inverter to start or stop via serial port. ☒ The command channels can be selected by setting Function Code P0.03, or by multifunctional input terminal (function code P4.00-P4.07).

Table 4-1 Running Command Channels

Note :

These three channels are all switchable. Please make debugging before switch so as to avoid equipment damage and personal injury.

4.2.2 Frequency setting channel

There are 8 kinds of frequency setting channels as follow:



Number	Channel	Number	Channel
0	by control panel potentiometer	1	by   control panel keys
2	digital setting by function code via control panel	3	via terminal UP/DOWN
4	by upper computer via serial port	5	analog setting via VI terminal
6	analog setting via CI terminal	7	via pulse terminal
8	combination setting		

Table 4-2 Frequency setting channel

4.2.3 Inverter Running States

There are 8 kinds of frequency setting channels as follow:

Channel	Control method
Standby state	When power switch on, inverter will be in standby state before receiving control command. Or receiving Stop command during inverter running, inverter will stop and standby.
Running state	After running control command is received, the inverter enters running state.

Table 4-3 Inverter Running States

4.2.4 The Running Modes of Inverter

There are five running modes according to priority which are JOG running, close loop running, PLC running, multi-stage speed running, and normal running as shown in Fig.4-4.

Running Modes	Control method
0 : JOG running	In stopping state, after receiving JOG running command, the inverter will run according to JOG frequency, for example, by pressing control panel  key to give JOG command(refer to function codeP3.06~P3.08).
1 : Close loop running	By setting close loop running control parameter enabled (P7.00=1), the inverter will enter close loop running, that is PI regulation (refer to function code P7). To make close loop running invalid, please set multifunctional input terminal (function27) and switch to lower priority running mode.
2 : PLC running	By setting PLC function parameter enabled (P8.00 ≠ 0), the inverter will enter PLC running mode and run according to preset running mode (refer to function code P8).To make PLC running invalid, please set multifunctional input terminal (function29) and switch to lower priority running mode.
3 : Multi-stage speed running	By setting non-zero combination of multifunctional input terminal (function1,2,3) and selecting multi-frequency 1-7, the inverter will enter multi-stage speed running mode(refer to function codeP3.26~P3.32).
4 : Normal running	Simple open loop running mode of inverter.

Table 4-4 The Running Modes of Inverter

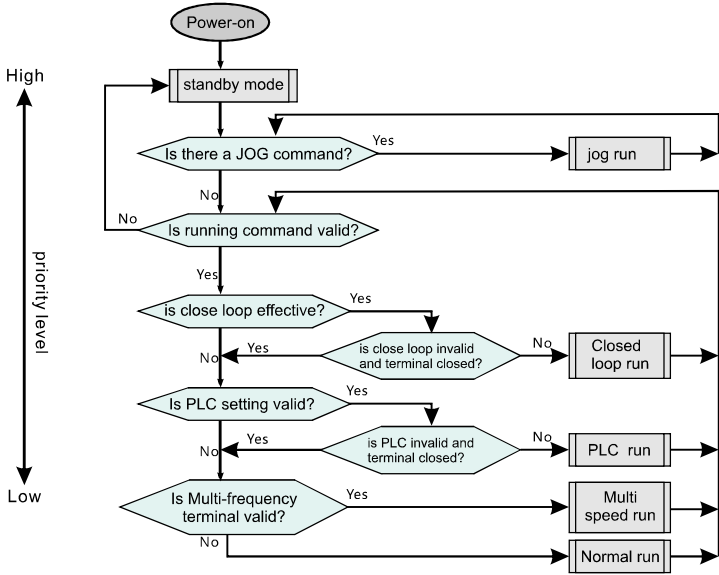

Figure 4-2 Running mode logic diagram

The above 5 kinds of running modes can be running in multiple frequency setting channel except JOG running. PLC running, multi-stage speed running and normal running can carry out swing frequency running

4.3 Introduction of the keypad

4.3.1 Keyboard interface

User can control inverters' start, frequency adjust, stop, braking, setup the running parameters and control peripheral equipment through control panel and control terminal.



Figure 4-3 Control panel diagram

4.3.2 Keyboard Introduction

Name		Function Description	
Status indicator	RUN	In keypad mode, pressing the key, inverter will run	
	LOCAL	<input type="radio"/> LOCAL/REMOT : OFF	Operation panel control
		<input checked="" type="radio"/> LOCAL/REMOT : PN	Terminal control
	<input checked="" type="radio"/> LOCAL/REMOT : Flash	Communication control	
Unit indicator	It represents the current display of the Keypad		
	Hz	<input checked="" type="radio"/> Hz <input type="radio"/> A <input type="radio"/> V RPM %	Frequency unit
	A	<input type="radio"/> Hz <input checked="" type="radio"/> A <input type="radio"/> V RPM %	Current unit
	V	<input type="radio"/> Hz <input type="radio"/> A <input checked="" type="radio"/> V RPM %	Voltage unit
	RPM	<input checked="" type="radio"/> Hz <input checked="" type="radio"/> A <input type="radio"/> V RPM %	Speed unit
%	<input type="radio"/> Hz <input checked="" type="radio"/> A <input checked="" type="radio"/> V RPM %	Percentage	











Name	Function Description					
Code Display Zone	There are a 4 digits LED display,display displays various monitoring data and alarm code such as set frequency and output frequency.					
	Display letter	Corresponding letter	Display letter	Corresponding letter	Display letter	Corresponding letter
	0	0	1	1	2	2
	3	3	4	4	5	5
	6	6	7	7	8	8
	9	9	A	A	b	b
	C	C	d	d	E	E
	F	F	H	H	I	I
	L	L	N	N	n	n
	o	o	P	P	r	r
	S	S	t	t	U	U
	v	v	.	.	-	-
Digital potentiometers		Left rotary, the same function as UP key. Right rotary, the same function as DOWN KEY Pressing potentiometer, the same function as 				
Keypad button zone		Run	In keypad mode, pressing the key, inverter will run			
		Multifunction	REV key is defined as Reverse function. It is also self-defined key which can be set by Parameter			
		Stop/Reset	Inverter in running status, pressing the key will stop inverter when command given by keypad. In fault status, pressing the key can reset			
		Function/Data	Enter or exit programming status			
		UP	Data or function code increment			
		DOWN	Data or function code increment			
		Shift/Monitor	In programming, the key can shift code digit. In other status, the key can shift monitoring parameter			
		Reserve/switch	In programming, the key can enter next step manual or reserve the setting			

Table 4-5 Keyboard function description

4.4 Control Panel Display State

The control panel display state includes parameter displaying in stopping state, function code parameter displaying in programming state, fault displaying in alarm state, and parameter displaying in running state.

4.4.1 Stopping state Parameter display

When inverter is in stopping state, panel displays stopping state monitoring parameter which usually is setting frequency (b-01 monitoring parameter) shown as Fig.4-4 B.

Press **▶▶** key to display the other monitoring parameter (The inverter default displays the first 7 monitoring parameters of b group. The other parameters can be defined by function code P3.41 and P3.42. Please refer to Chapter 5). Press key for switching to default display parameter b-01, which is setting frequency, or it will display the last monitoring parameter.



Figure A
Power on to initialize the display dynamic picture



Figure B
Stop status, display downtime parameter



Figure C
Running status, showing the operating status parameters

Figure 4-4 Parameter display in initialization, stopping and running state

4.4.2 Parameter displaying in running state

The inverter enters running state after receiving valid running command, and the panel displays running state monitoring parameter. The default displaying is output frequency (b-00 monitoring parameter) shown as Fig.4-4 C.

Press **▶▶** key can display the monitoring parameter in running state (defined by function code P3.41 and 3.42). While parameter displaying, press **▶▶▶▶** key for switching to default display parameter b-00, that is output frequency, or it will display the last monitoring parameter.

4.4.3 Fault displaying in alarm state

The Inverter enters fault alarm display state after fault signal detected. The displayed fault code will be flashing.

Press **▶▶** key to check fault related parameter. When checking fault related parameter, press **ENTER** key for switching to Fault code display.

Press **MENU** key to enter programming state to check P6 group parameter of fault information. After troubleshooting, press **STOP** key to reset the inverter (or via control terminal/serial port). If the fault still exists, it will keep displaying the fault code.



Figure 4-5 Fault alarm display state

Note :

To some serious fault such as IGBT protection, over current, over voltage, etc. Don't reset the inverter before clearing the fault for sure, otherwise there is a danger of damage.

4.4.4 Function code programming state

In the state of stopping, running, and fault alarm, press **MENU** key to enter programming state (A password is required, if it has been set. Please refer to P0.00 description and Fig.4-9). The programming state includes three level display menus shown as Fig.4-6 which in order are function code group → function code number → function code parameter. Press **ENTER** key to enter each menus. When in function code parameter display menu, press **ENTER** key to save parameter, press **ENTER** key to go back to previous menu without parameter saving.

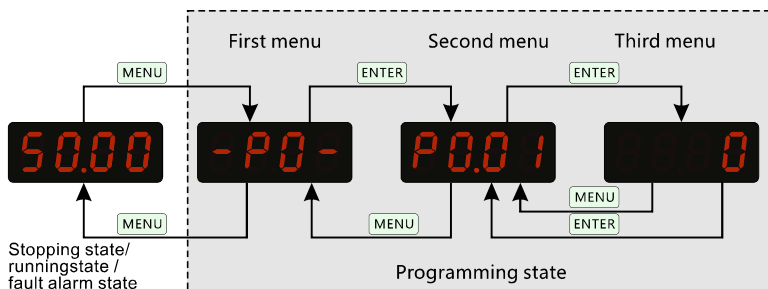

Figure 4-6 Control panel programming state

4.5 Keyboard operation

Through the operating panel of inverter for various operations, for example as follows:

4.5.1 Switching display of state monitoring parameter

Press **▶▶** key to display b group state monitoring parameter. It first displays the code of monitoring parameter, after 1 second, it switches automatically to display the value of this monitoring parameter shown as Fig.4-7.

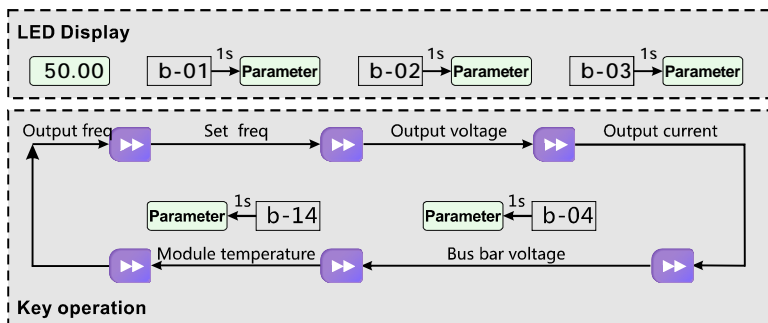

Figure 4-7 Operation to display monitoring parameter

When viewing monitoring parameter, press **ENTER** key for switching to default monitoring parameter display state. Default monitoring parameter is setting frequency in stopping state. In running state, the default monitoring parameter is output frequency.

4.5.2 Function code parameter setting

For example, to set parameter code P3.06 from 5.00Hz to 8.50Hz.

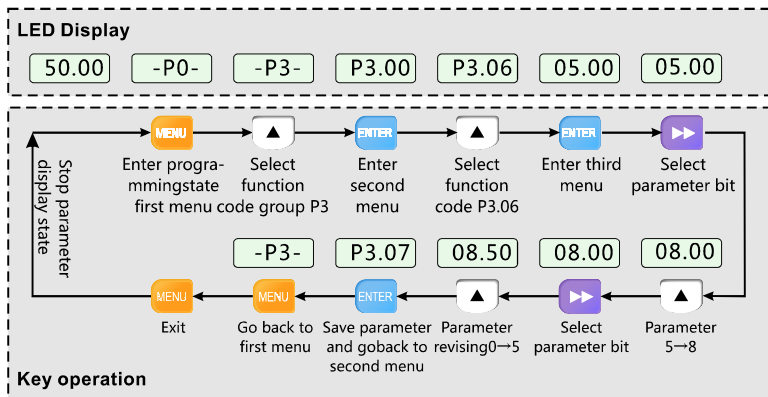

Figure 4-8 Example of function code parameter setting

Note :

In third level menu, if the parameter displayed is not in flashing, it means that this function code is unable to be revised. Probably the reasons are:

- This function code parameter is unmodifiable, such as actual detected state parameter, record running parameter, etc.
- This function code parameter can not be revised in running state. It just can be revised in stopping state.
- The parameter is under protection. When function code P3.01 unit's place is 1 or 2, all function code parameter can not be revised. This is parameter protection to avoid fault operation. Set P3.01 unit's place as 0 to make modification available.

4.5.3 JOG running operation

Following is an example. Suppose it is in panel control mode and in stopping state, JOG running frequency is 5Hz.

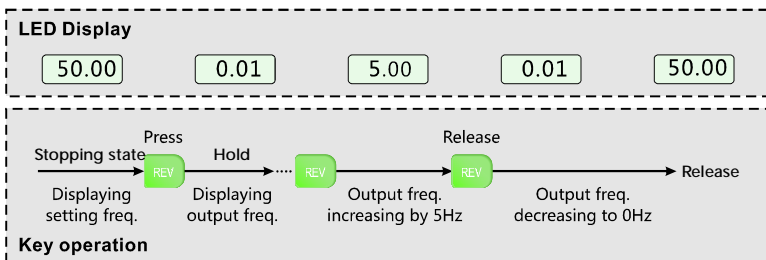

Figure 4-9 JOG running operation

4.5.4 Password authentication operation

Suppose P9.14 password parameter has been set as “2345”. The authentication operation is shown as Fig. 4-10. The bold figure represents the flashing bit.

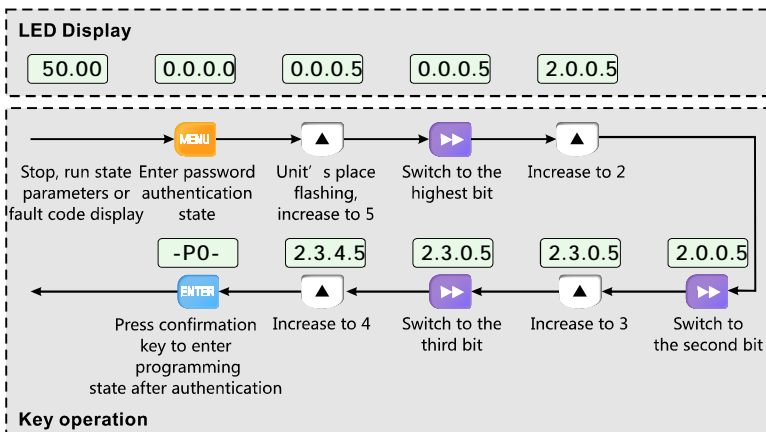

Figure 4-10 Example of password authentication operation

4.5.5 Inquiring fault related parameter

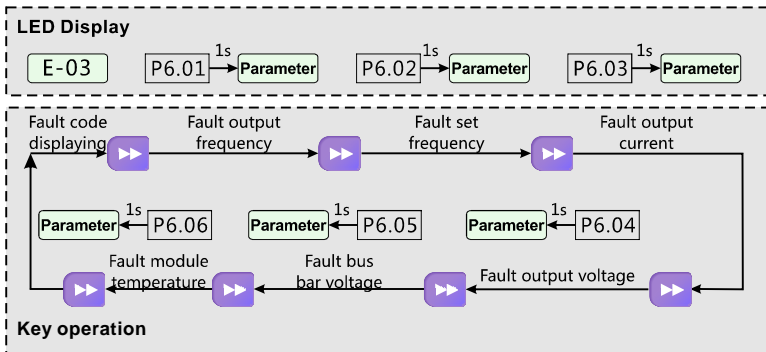

Figure 4-11 Example of inquiring fault related parameter

Note :

- In fault code display state, press key to inquire P6 group function code parameter. The range is from P6.01 to P6.06. After pressing key, LED first displays function code, and 1 second later it displays automatically the value of this function code parameter.
- When inquiring fault parameter, press key to switch back to fault code display state.

4.5.6 Frequency setting operation by control panel 、 keys

Suppose it is in stopping state and P0.01=1, the operation is as follow.

- Frequency integral adjustment.
- As press key and hold it, LED begins to increase from unit's digit to ten's digit, and then to hundred's digit. If release key and then press key again, LED will increase from unit's digit again.
- As press key and hold it, LED begins to decrease from unit's digit to ten's digit, and then to hundred's digit. If release key and then press key again, LED will decrease from unit's digit again.

4.5.7 Frequency setting operation by control panel 、 keys

Press key for 5 seconds to lock control panel key. It displays 'LOCC', as panel locked.

4.5.8 Control panel key unlock operation

Press  key for 5 seconds to unlock control panel key.

Chapter 5

Function Parameter Table

5.1 Symbol Description	56
5.2 Function Code Table.....	56

5.1 Symbol Description

“o”: means that the parameter can be modified during running state.

“x”: means that the parameter can not be modified during running state.

“*”: means read-only parameter which can not be modified.

5.2 Function Code Table

Func Code	Name	Range	Min Unit	Factory Default	Modify
P0 Group: Basic running function parameter					
P0.00	Control mode selection	0 : V/F Control 1 : Senseless vector control	1	0	o
P0.01	Freq control channel selection	0 : Analog potentiometer on control panel(single display valid) 1 : ▲、▼key on control panel(single display valid) Panel digital potentiometer+▲、▼key on control panel(double display valid) 2 : Digital setting 1,control panel given 3 : Digital setting 2, UP/DOWN terminal given 4 : Digital setting 3, serial port given 5 : VI analog given (VI-GND) 6 : CI analog given(CI-GND) 7 : Pulse terminal given(PULSE) 8 : Combination given (refer to P3.00)	1	0	o
P0.02	Running frequency set	P0.19lower limit freq.~P0.20upper limit freq.	0.01HZ	50.00HZ	o
P0.03	Running command mode selection	0 : Control panel mode 1 : Terminal control mode 2 : Serial port control mode	1	0	o
P0.04	Running direction setting	Unit's digit: 0: Forward 1:Reverse Ten's digit: 0:REV allowed 1:REV prohibited	1	10	o
P0.05	FWD/REV dead time	0.0~120.0s	0.1s	0.1s	o

Func Code	Name	Range	Min Unit	Factory Default	Modify
P0.06	Max output freq.	50.00Hz~500.00Hz	0.01HZ	50.00HZ	×
P0.07	Basic running freq	1.00Hz~500.00Hz	0.01HZ	50.00HZ	×
P0.08	Max output voltage	1~480V	1V	inverter rated voltage	×
P0.09	Torque boost	0.0%~30.0%	0.1%	2.0%	×
P0.10	Torque boost cut-off freq.	0.00Hz~Basic running freq.P0.07	0.00	50.00Hz	○
P0.11	Torque boost mode	0: Manual 1: Auto	1	0	○
P0.12	Carrier freq	1.0K~14.0K	0.1K	8.0K	×
P0.13	Acc/Dec mode selection	0: Linear Acc/Dec 1: Curve Acc/Dec	1	0	×
P0.14	Time of S curve start stage	10.0%~50.0% (Acc/Dec time) P0.14 + P0.15 ≪ 90%	0.1%	20.0%	○
P0.15	Time of S curve ascent stage	10.0%~80.0% (Acc/Dec time) P0.14 + P0.15 ≪ 90%	0.1%	60.0%	○
P0.16	Acc/Dec time unit	0: Second 1: Minute	0	0	×
P0.17	Acc time 1	0.1~6000.0	0.1	20.0	○
P0.18	Dec time 1	0.1~6000.0	0.1	20.0	○
P0.19	Upper limit freq.	Lower limit freq. ~Max output freq.P0.06	0.01Hz	50.00Hz	×
P0.20	Lower limit freq.	0.00Hz~Upper limit freq.	0.01Hz	0.00Hz	×
P0.21	Lower limit freq. Running mode	0: Running at lower limit freq 1: Stopping	1	0	×
P0.22	V/F curve setting	0: Constant torque curve 1: Reduced torque curve 1 (1.2 times the power) 2: Reduced torque curve 2 (1.7 times the power) 3: Reduced torque curve 3 (2.0 times the power) 4: Customized V/F curve	1	0	×

Func Code	Name	Range	Min Unit	Factory Default	Modify
P0.23	V/F Freq.valueP3	P0.25~P0.07 Basic running freq.	0.01Hz	0.00Hz	×
P0.24	V/F Volt.valueV3	P0.26~100.0%	0.1%	0.0%	×
P0.25	V/F Freq.valueP2	P0.27~P0.23	0.01Hz	0.00Hz	×
P0.26	V/F Volt.valueV2	P0.28~P0.24	0.1%	0.0%	×
P0.27	V/F Freq.valueP1	0.00~P0.25	0.01Hz	0.00Hz	×
P0.28	V/F Volt.valueV1	0~P0.26	0.1%	0.0%	×
P1 Group: Basic running function parameter					
P1.00	Analog filtering time constant	0.01~30.00s	0.01s	0.20s	○
P1.01	VI channel gains	0.01~9.99	0.01	1.00	○
P1.02	VI min given	0.00~P1.04	0.01Hz	0.00V	○
P1.03	Corresponding freq. to VI min given	0.00~Upper limit freq.	0.01Hz	0.00Hz	○
P1.04	VI max given	P1.04~10.00V	0.01V	10.00V	○
P1.05	Corresponding freq. to VI max given	0.00~Upper limit freq.	0.01Hz	50.00Hz	○
P1.06	CI channel gains	0.01~9.99	0.01	1.00	○
P1.07	CI min given	0.00~P1.09	0.01V	0.00V	○
P1.08	Corresponding freq. to CI min given	0.00~Upper limit freq	0.01Hz	0.00Hz	○
P1.09	CI max given	P1.07~10.00V	0.01V	10.00V	○
P1.10	Corresponding freq. to CI max given	0.00~Upper limit freq	0.01Hz	50.00Hz	○
P1.11	Max input pulse freq	0.1~20.0K	0.1K	10.0K	○
P1.12	Pulse min given	0.0~P1.14(Pulse max given)	0.1K	0.0K	○
P1.13	Corresponding freq. to pulse min given	0.00~Upper limit freq	0.01Hz	0.00Hz	○
P1.14	Pulse max given	P1.12(Pulse min given)~P1.11(Max input pulse freq.)	0.1K	0.1K	○
P1.15	Corresponding freq. to pulse max given	0.00~Upper limit freq	0.01Hz	50.00Hz	○

Func Code	Name	Range	Min Unit	Factory Default	Modify
P2 Group: Start/Brake function parameter					
P2.00	Start running mode	0: Start from start freq. 1: Brake first, then start from start freq. 2: Track speed, then start.	1	0	×
P2.01	Start freq.	0.40~20.00Hz	0.01Hz	0.50Hz	○
P2.02	Start freq. running duration	0.0~30.0s	0.1s	0.0s	○
P2.03	DC brake current as start	0~15%	1%	0%	○
P2.04	DC brake time as start	0.0~60.0s	0.1s	0.0s	○
P2.05	Stop mode	0: Dec 1: Free Stop 2: Dec+ DC brake	1	0	×
P2.06	Start freq. of DC brake as stop	0.0~15.00Hz	0.0Hz	3.00Hz	○
P2.07	DC brake time as stop	0.0~60.0s	0.1s	0.0s	○
P2.08	DC brake current as stop	0~15%	1%	0%	○
P3 Group :Auxiliary running parameter					
P3.00	Freq. control channel combination	0: VI + CI 1: VI - CI 2: External pulse given + VI + control panel▲、▼key given 3: External pulse given - VI - control panel▲、▼key given 4: External pulse given + CI 5: External pulse given - CI 6: RS485 given + VI + control panel▲、▼key given 7: RS485 given - VI - control panel▲、▼key given 8: RS485 given + CI + control panel▲、▼key given	1	0	×

Func Code	Name	Range	Min Unit	Factory Default	Modify
P3.00	Freq. control channel combination	9: RS485 given - CI - control panel▲、▼key given 10: RS485 given + CI + External pulse given 11: RS485 given - CI - External pulse given 12: RS485 given + VI + External pulse given 13: RS485 given - VI - External pulse given 14: VI + CI + control panel▲、▼key given + digital given (P0.02) 15: VI + CI - control panel▲、▼key given + digital given (P0.02) 16: MAX (VI, CI) 17: MIN (VI, CI) 18: MAX (VI, CI, PULSE) 19: MIN (VI, CI, PULSE) 20: VI, CI(Availability except 0,VI prior) 21: VI+ Terminal UP/DOWN 22: CI+ Terminal UP/DOWN	1	0	×
P3.01	Parameter initialization setting	LED unit's digit: 0: All parameters are allowed to be modified. 1: All parameters are not allowed to be modified except this parameter itself. 2: All parameters are not allowed to be modified except P0.02 parameter and this parameter itself LED ten's digit: 0: Inaction 1: Factory default reset 2: Clear history fault record	1	0	×
P3.02	Parameter copy	0: Inaction 1: Parameter upload 2: Parameter download Note: only valid in remote control mode	1	0	×

Func Code	Name	Range	Min Unit	Factory Default	Modify
P3.03	Auto energy save running	0: Inaction 1: Action	1	0	×
P3.04	AVR function	0: Inaction 1: Always action 2: Inaction only in Dec	1	0	×
P3.05	Slip freq. compensation	0~150%	1%	0%	×
P3.06	JOG running freq.	0.10~50.00Hz	0.01Hz	5.00Hz	○
P3.07	JOG Acc time	0.1~60.0s	0.1s	20.0s	○
P3.08	JOG Dec time	0.1~60.0s	0.1s	20.0s	○
P3.09	Communication configuration	LED unit's place: baud rate selection 0: 1200BPS 1: 2400BPS 2: 4800BPS 3: 9600BPS 4: 19200BPS 5: 38400BPS LED ten's place: data format 0: 1-7-2 Format, without check 1: 1-7-1 Format, odd parity check 2: 1-7-1 Format, even parity check 3: 1-8-2 Format, without check 4: 1-8-1 Format, odd parity check 5: 1-8-1 Format, even parity check 6: 1-8-1 Format, without check LED hundred's place: communication mode 0: MODBUS, ASCII Mode 1: MODBUS, RTU Mode	1	005	×
P3.10	Local address	0~248 0: Broadcast address 248: Host address	1	1	×
P3.11	Communication overtime detection time	0.0~1000.0s 0.0: Function invalid	0.1s	0.0s	×
P3.12	Local response delay	0~1000ms	1s	5ms	×
P3.13	Multi-running proportion	0.01~1.00	0.01	1.00	×

Func Code	Name	Range	Min Unit	Factory Default	Modify
P3.14	Acc time2	0.1~6000.0	0.1	20.0	○
P3.15	Dec time2	0.1~6000.0	0.1	20.0	○
P3.16	Acc time3	0.1~6000.0	0.1	20.0	○
P3.17	Dec time3	0.1~6000.0	0.1	20.0	○
P3.18	Acc time4	0.1~6000.0	0.1	20.0	○
P3.19	Dec time4	0.1~6000.0	0.1	20.0	○
P3.20	Acc time5	0.1~6000.0	0.1	20.0	○
P3.21	Dec time5	0.1~6000.0	0.1	20.0	○
P3.22	Acc time6	0.1~6000.0	0.1	20.0	○
P3.23	Dec time6	0.1~6000.0	0.1	20.0	○
P3.24	Acc time7	0.1~6000.0	0.1	20.0	○
P3.25	Dec time7	0.1~6000.0	0.1	20.0	○
P3.26	Multi-stage freq.1	Multi-stage freq.1	0.01Hz	5.00Hz	○
P3.27	Multi-stage freq.2	Multi-stage freq.2	0.01Hz	10.00Hz	○
P3.28	Multi-stage freq.3	Multi-stage freq.3	0.01Hz	20.00Hz	○
P3.29	Multi-stage freq.4	Multi-stage freq.4	0.01Hz	30.00Hz	○
P3.30	Multi-stage freq.5	Multi-stage freq.5	0.01Hz	40.00Hz	○
P3.31	Multi-stage freq.6	Multi-stage freq.6	0.01Hz	45.00Hz	○
P3.32	Multi-stage freq.7	Multi-stage freq.7	0.01Hz	50.00Hz	○
P3.33	Jump freq.1	0.00~500.00Hz	0.01Hz	0.00Hz	×
P3.34	Jump freq.1range	0.00~30.00Hz	0.01Hz	0.00Hz	×
P3.35	Jump freq.2	0.00~500.00Hz	0.01Hz	0.00Hz	×
P3.36	Jump freq.2range	0.00~30.00Hz	0.01Hz	0.00Hz	×
P3.37	Reserved	0000~9999	1	0000	×
P3.38	Zero frequency DC braking voltage	0.0%~15.0%	0.1%	0.0%	×
P3.39	Set running time	0~65.535K hour	0.001K	0.000K	○

Func Code	Name	Range	Min Unit	Factory Default	Modify
P3.40	Total running	0~65.535K hour	0.001K	0.000K	○
P3.41	Inspection speed start wait time	00.0~60.0	0.1s	2.0 s	○
P3.42	Inspection speed and start the	00.0~150.0%	0.1%	100.0 %	○
P3.43	Running display parameter selection1	00~15	1	00	○
P3.44	Stop display parameter selection 2	00~15	1	00	○
P3.45	No unit display coefficient	0.1~60.0	0.1	29.0	○
P3.46	JOG/REV Switching control	0: Select the JOG point operation 1: Select the REV reverse operation	1	0	×
P4 Group: Terminal control function parameter					
P4.00	Input terminal X1 function selection	0: Idle terminal 1: Multi-stage speed control terminal 1 2: Multi-stage speed control terminal 2 3: Multi-stage speed control terminal 3 4: External FWD JOG control input 5: External REV JOG control input 6: Acc/Dec time terminal 1 7: Acc/Dec time terminal 2 8: Acc/Dec time terminal 3 9: 3-wire control 10: Free stop input (FRS) 11: External stop command 12: Stopping DC brake input command DB 13: Inverter running prohibited 14: Freq. increase command(UP) 15: Freq. decrease command(DOWN) 16: Acc/Dec prohibited command 17: External reset input (clear fault) 18: Peripheral equipment fault input (normally open) 19: Freq. control channel selection 1 20: Freq. control channel selection 2 21: Freq. control channel selection 3 22: Command switched to terminal 23: Running command control mode selection 1	1	0	×

Func Code	Name	Range	Min Unit	Factory Default	Modify
P4.00	Input terminal X1 function selection	24: Running command control mode selection 2 25: Swing frequency selection 26: Swing frequency running reset 27: Close loop invalid 28: Simple PLC pause running command 29: PLC invalid 30: PLC Reset in stopping state 31: Freq. switch to Cl 32: Counter trig signal input 33: Counter clear input 34: External interrupt input 35: Pulse freq. input (only valid for X6) 36: Fire mode	0.1	20.0	○
P4.01	Input terminal X2 function selection	Ditto	1	0	×
P4.02	Input terminal X3 function selection	Ditto	1	0	×
P4.03	Input terminal X4 function selection	Ditto	1	0	×
P4.04	Input terminal X5 function selection	Ditto	1	0	×
P4.05	Input terminal X6 function selection	Ditto	1	0	×
P4.06	Input terminal X7 function selection	Ditto	1	0	×
P4.07	Input terminal X8 function selection	Ditto	1	0	×
P4.08	FWD/REV running mode selection	0: 2-wire control mode 1 1: 2-wire control mode 2 2: 3-wire control mode 1 3: 3-wire control mode 2	1	0	×
P4.09	UP/DN Rate	0.01-99.99Hz/s	0.01	1.00 Hz/s	○

Func Code	Name	Range	Min Unit	Factory Default	Modify
P4.10	2-way open collector output terminal OC1 output selection	0: Inverter in running(RUN) 1: Freq. arrival signal(FAR) 2: Freq. level detected signal(FDT1) 3: Reserved 4: Overload pre-alarm signal(OL) 5: Under voltage locking(LU) 6: External fault stopping (EXT) 7: Output freq. upper limit(FH) 8: Output freq. lower limit(FL) 9: Inverter in zero speed running 10: Simple PLC stage running finish 11: A PLC running cycle finish 12: Set counts arrival 13: Specified counts arrival 14: Inverter ready for running(RDY) 15: Inverter fault 16: Start freq. running time 17: DC brake time when start 18: DC brake time when stop 19: Swing freq. upper/lower limit 20: Set running time arrival 21: Upper limit of pressure alarm signal 22: Lower pressure alarm signal	1	0	×
P4.11	2-way open collector output terminal OC2 output selection	Ditto	1	0	×
P4.12	Relay TA/TB/TC output selection	Ditto	1	15	×
P4.13	Relay RA/RB/RC output selection	Ditto	1	0	×
P4.14	Freq. arrival detection range	0.00~400.00Hz	0.01Hz	5.00Hz	×
P4.15	FDT1(freq. level)	0.00~Upper limit freq	0.01Hz	10.00Hz	×

Func Code	Name	Range	Min Unit	Factory Default	Modify
P4.16	FDT1 lag	0.00~50.00Hz	0.01Hz	1.00Hz	○
P4.17	Analog output (Ao1) selection	unit's place: Output freq.(0~upper limit freq.) 1: Output current(0~2 times motor rated current) 2: Output voltage(0~1.2 times inverter rated voltage) 3: Bus bar voltage 4: PID given 5: PID feedback 6: Vi (0~10V) 7: Ci(0~10V/4~20mA) ten's place: 0: 0~10V 1: 0~20mA 2: 4~20mA	01	00	○
P4.18	Analog	Analog output (AO1) gain	0.01	1.00	○
P4.19	Analog output (AO2) selection	unit's place: Output freq.(0~upper limit freq.) 1: Output current(0~2 times motor rated current) 2: Output voltage(0~1.2 times inverter rated voltage) 3: Bus bar voltage 4: PID given 5: PID feedback 6: Vi (0~10V) 7: Ci(0~10V/4~20mA) ten's place: 0: 0~10V 1: 0~20mA 2: 4~20mA	01	00	○
P4.20	Analog output (AO2) gain	0.50~2.00	0.01	1.00	○
P4.21	DO output terminal	unit's place: 0: Output freq.(0~upper limit freq.) 1: Output current(0~2 times motor rated current) 2: Output voltage(0~1.2 times inverter rated voltage)	1	0	○

Func Code	Name	Range	Min Unit	Factory Default	Modify
P4.21	DO output terminal	3: Bus bar voltage (0~800V) 4: PID given 5: PID feedback 6: VI (0~10V) 7: CI(0~10V/4~20mA)	1	0	○
P4.22	DO max pulse output freq.	0.1K~20.0K (max 20KHz)	0.1KHz	10.0KHz	○
P4.23	Set counts given	F4.20~9999	1	0	○
P4.24	Specified counts given	0~F4.19	1	0	○
P4.25	Overload pre-alarm detection level	20~200%	1	130%	○
P4.26	Overload pre-alarm delay time	0.0~20.0s	0.1s	5.0s	○
P5 Group: Protection function parameter					
P5.00	Motor overload protection mode selection	0 : Stop outputting 1 : Inaction	1	0	×
P5.01	Motor overload protection coefficient	20~120%	1	100%	×
P5.02	Overvoltage stall Selection	0 : Prohibited 1 : Allowed	1	1	×
P5.03	Overvoltage stall point	380V : 120~150% 220V : 110~130%	1%	140% 120%	○
P5.04	Auto current limit level	110%~200%	1%	150%	×
P5.05	Freq. drop rate during current limit	0.00~99.99Hz/s	0.01Hz/s	10.00Hz/s	○
P5.06	Auto current limit mode selection	0 : Constant speed invalid 1 : Constant speed valid Note: Acc/Dec valid	1	1	×
P5.07	Restart setting after power failure	0 : Inaction 1 : Action	1	0	×
P5.08	Restart waiting time after power failure	0.0~10.0s	0.1s	0.5s	×
P5.09	Fault self-recovery times	0~10 0 : Self-recovery invalid Note : Self-recovery invalid in overload or overheat	1	0	×

Func Code	Name	Range	Min Unit	Factory Default	Modify
P5.10	Self-recovery interval time	0.5~20.0s	0.1s	5.0s	×
P5.11	Input missing phase protection	0 : Inaction 1 : Action	1	0	○
P6 Group: Fault record function parameter					
P6.00	Previous failure record	Previous failure record	1	0	*
P6.01	Output frequency at the previous fault	Output frequency at the previous fault	0.01Hz	0	*
P6.02	Set frequency at the previous fault	Set frequency at the previous fault	0.01Hz	0	*
P6.03	Output current at the previous fault	Output current at the previous fault	0.1A	0	*
P6.04	Output voltage at the previous fault	Output voltage at the previous fault	1V	0	*
P6.05	DC bus voltage at the previous fault	DC bus voltage at the previous fault	1V	0	*
P6.06	Module temperature at the previous fault	Module temperature at the previous fault	10C	0	*
P6.07	Previous secondary fault record	Previous secondary fault record	1	0	*
P6.08	Previous third failure records	Previous third failure records	1	0	*
P6.09	Previous fourth failure record	Previous fourth failure record	1	0	*
P6.10	Previous fifth failure record	Previous fifth failure record	1	0	*
P6.11	Previous sixth failure record	Previous sixth failure record	1	0	*
P7 Group: Close loop running control function parameter					
P7.00	Close loop running control selection	0: Invalid 1: Valid	1	0	×
P7.01	Close loop given channel selection	0: P7.05 Digital given + panel▲ · ▼Fine tuning 1: VI analog 0~10V voltage given 2: CI analog 0~10V given 3: Panel analog potentiometer given 4: RS485 communication given 5: Pulse input given 6: CI simulation4~20mA Current setting	1	0	×
P7.02	Feedback channel selection	0: VI analog 0~10V input voltage 1: CI analog input (0~10V/0~20mA) 2: VI+CI 3: VI-CI	1	0	×

Func Code	Name	Range	Min Unit	Factory Default	Modify
P7.02	Feedback channel selection	4: Min {VI · CI} 5: Max {VI · CI} 6: CI analog input (4~20mA)	1	0	×
P7.03	Given channel filtering time constant	0.01~50.00s	0.01s	0.50s	○
P7.04	Feedback channel filtering time constant	0.01~50.00s	0.01s	0.50s	○
P7.05	Given value digital setting	0.001~20.000Mpa	0.001 Mpa	0.000M pa	×
P7.06	Close loop adjustment characteristics	0: Positive effect 1: Negative effect	1	0	○
P7.07	Feedback channel gain	0.01~10.00	0.01	1.00	○
P7.08	Lower pressure limit	0.001~P7.09	0.001	0.001	○
P7.09	Upper pressure limit	P7.08~P7.27	0.001	1.000	○
P7.10	PID Controller structure	0: Proportional control 1: Integral control 2: Proportional integral control 3: Proportional, integral and differential control	1	1	×
P7.11	Proportional gain KP	0.00~5.00	0.01	0.50	○
P7.12	Integral time constant	0.1~100.0s	0.1	10.0s	○
P7.13	Differential gain	0.0~5.0	0.1	0.0	×
P7.14	Sampling period	0.01~1.00s	0.01	0.10	○
P7.15	Tolerance limit	0.0~20.0%	0.1%	0.0%	○
P7.16	PID Feedback disconnected detection threshold	0~Upper limit freq	0.01Hz	0.00Hz	○
P7.17	PID Feedback disconnected action selection	0~3	1	0	○
P7.18	PID Feedback disconnected operation delay time	0.01~5.00s	0.01s	1.00s	○

Func Code	Name	Range	Min Unit	Factory Default	Modify
P7.19	Pressure level.	0.001~P7.20	0.001 Mpa	0.001Mpa	○
P7.20	Hibernation pressure level	P7.19~P7.27	01	00	○
P7.21	Hibernation level continuous time	0~250s	1s	10s	○
P7.22	Hibernation frequency	0.00~400.0Hz	0.01Hz	20.00Hz	○
P7.23	Hibernation frequency continuous time	0~250s	1s	10s	○
P7.24	Low alarm limit pressure	0.001~P7.25	0.001 Mpa	0.001Mpa	○
P7.25	The alarm limit pressure	P7.24~P7.27	0.001 Mpa	0.001Mpa	○
P7.26	Constant pressure water supply mode	0: Non-constant pressure water supply mode 1: One pump constant pressure water supply mode 2: Two pumps constant pressure water supply mode 3: Three pumps constant pressure water supply mode 4: Four pumps constant pressure water supply mode	1	0	×
P7.27	Remote pressure gauge range	0.001~20.000Mpa	0.001 Mpa	1.000Mpa	○
P7.28	Multi pump operation mode	0: Fixed sequence switch 1: Timing of the rotation	1	0	○
P7.29	Rotation in timed intervals	0.5~100.0H	0.1H	5.0H	○
P7.30	Pump switching judgment time	0.1~1000.0s	0.1s	300.0s	○
P7.31	Electromagnetic switching delay time	0.1~10.0s	0.1s	0.5s	×
P7.32	PID Control of positive and negative role and feedback pressure error polarity	Unit's digit: 0: PID forward action; 1: PID reverse action. Ten's digit : 0: The feedback pressure is greater than the actual pressure;	1	00	×

Func Code	Name	Range	Min Unit	Factory Default	Modify
P7.32	PID Control of positive and negative role and feedback pressure error polarity	1: feedback pressure is less than actual pressure. Hundreds' digit: 0: wake up sleep pressure is actual pressure; 1: wake up sleep pressure is set pressure. Thousands' digit: 0: Press to view the monitoring parameters, and the B group monitoring parameters are viewed in order; 1: Press to view the monitoring parameters. The monitoring parameters of group B only view the three parameters of set pressure, output current and output frequency.	1	00	×
P7.33	Feedback error of pressure adjustment coefficient	0.001~20.000Mpa	0.001 Mpa	0.000Mpa	×
P7.34	Closed loop of preset frequency	Range: 0~Upper limit freq	0.00Hz	0.00Hz	×
P7.35	Closed loop of preset frequency holding time	Range: 0.0~200.0s	0.1s	0.0s	×
P8 Group PLC running parameter					
P8.00	PLC running mode selection	0000~1113 LED unit 's place: mode selection 0: Inaction 1: Stop after single cycle 2: Running at final freq after single cycle 3: Continuous cycle LED ten's place: restart mode selection 0: Restart from the first stage 1: Restart from the freq. of break stage 2: Restart from the running. of break stage LED hundred's place: parameter save mode selection	1	0000	×

Func Code	Name	Range	Min Unit	Factory Default	Modify
P8.00	PLC running mode selection	0: No save 1: Save LED thousand's place: running time unit 0: Second 1: minute	1	0000	×
P8.01	Stage 1 setting	000~621 LED unit 's place: freq setting 0: Multi-stage freq i (i=1~7) 1: Freq. defined by P0.01 function code LED ten's place: direction selection 0: Forward 1: Reverse 2: Controlled by running command LED hundred's place: Acc/Dec time selection 0: Acc/Dec time 1 1: Acc/Dec time 2 2: Acc/Dec time 3 3: Acc/Dec time 4 4: Acc/Dec time 5 5: Acc/Dec time 6 6: Acc/Dec time 7	1	000	○
P8.02	Stage 1 running time	0.1~6000.0	0.1	10.0	○
P8.03	Stage 2 setting	000~621	1	000	○
P8.04	Stage 2 running time	0.1~6000.0	0.1	10.0	○
P8.05	Stage 3 setting	000~621	1	000	○
P8.06	Stage 3 running time	0.1~6000.0	0.1	10.0	○
P8.07	Stage 4 setting	000~621	1	000	○
P8.08	Stage 4 running time	0.1~6000.0	0.1	10.0	○
P8.09	Stage 5 setting	000~621	1	000	○
P8.10	Stage 5 running time	0.1~6000.0	0.1	10.0	○
P8.11	Stage 6 setting	000~621	1	000	○
P8.12	Stage 6 running time	0.1~6000.0	0.1	10.0	○

Func Code	Name	Range	Min Unit	Factory Default	Modify
P8.13	Stage 7 setting	000~621	1	000	○
P8.14	Stage 7 running time	0.1~6000.0	0.1	10.0	○
P9 Group Swing frequency function parameter					
P9.00	Swing freq. selection	0: Inaction 1: Action	1	0	×
P9.01	Swing freq. running mode	0000~11 LED unit's place: start mode 0: Auto start 1: Manual start by terminal LED ten's place: swing amplitude control 0: Variable swing amplitude 1: Fixed swing amplitude	1	00	×
P9.02	Preset swing freq.	0.00~500.00Hz	0.01Hz 0.1s	0.00Hz	○
P9.03	Preset swing freq. waiting time	0.0~3600.0s	0.1s	0.0s	○
P9.04	Swing amplitude	0.0~50.0%	0.1%	0.0%	○
P9.05	Kick freq.	0.0~50.0%	0.1%	0.0%	○
P9.06	Swing freq. cycle	0.1~999.9s	0.1s	10.0s	○
P9.07	delta wave ascent time	0.0~98.0%	0.1%	50.0%	○
P9.08	Terminal UP/DOWN and Fan control selection	unit's digit: 0: fan running when the inverter is running 1: The fan is running when power is on 2: The fan does not run at zero-frequency ten's digit: 0: Keep the frequency parameter setting after it stops working or the power is off. 1: Release the frequency parameter settings after it stops working or the power is off. hundred's digit: 0: The terminal run command is valid when the power is on 1: The terminal run command is invalid when power is on	1	0	○

Func Code	Name	Range	Min Unit	Factory Default	Modify
P9.09	Muti-function terminal filtering time	Range : 0~4	1	1	○
P9.10	Braking unit use rate	0~100.0%	0.1%	30.0%	○
P9.11	Overpressure threshold value	0~780V	1V	780V	○
P9.12	Energy consumption braking bus bar voltage	0~780V	1V	640V Or 358V	○
P9.13	G/P type setting and single-phase motor type selection	Unit's digit: 0: G type 1:P type Ten's digit: reserved Hundred's digit: reserved Thousand's digit: Single-phase motor type: 0: ordinary three-phase asynchronous motor(220V) 1: single-phase asynchronous motor (removing capacitor) 2: Single-phase asynchronous motor (without removing the capacitor)	0000	0000	○
P9.14	User password	1~9999	1	0	○
PA Group: Vector control parameter					
PA.00	Motor parameter Auto tuning function	0 : Inaction 1 : Static auto tuning	1	0	×
PA.01	Motor rated voltage	0~400V	1	depends on model type	×
PA.02	Motor rated current	0.01~500.00A	0.01A	depends on model type	×
PA.03	Motor rated frequency	1~500Hz	1Hz	depends on model type	×
PA.04	Motor rated rotating speed	1~9999 r/min	1r/min	depends on model type	×
PA.05	Motor poles number	2~16	1	depends on model type	×
PA.06	Motor stator inductance	0.1~5000.0mH	0.1mH	depends on model type	×

Func Code	Name	Range	Min Unit	Factory Default	Modify
PA.07	Motor rotor inductance	0.1~5000.0mH	0.1mH	depends on model type	×
PA.08	Motor stator and rotor mutual inductance	0.1~5000.0mH	0.1mH	depends on model type	×
PA.09	Motor stator resistance	0.001~50.000Ω	0.001Ω	depends on model type	×
PA.10	Motor rotor resistance	0.001~50.000Ω	0.001Ω	depends on model type	×
PA.11	Over current protection coefficient of torque current	0~15	1	15	×
PA.12	Proportion adjustment coefficient of speed deviation	50~120	1	85	×
PA.13	Integral adjustment coefficient F speed deviation	100~500	1	360	×
PA.14	Vector torque boost	100~150	1	100	×
PA.15	Reserved	0	0	0	×
PA.16	Reserved	1~5	1	4	×
PA.17	Reserved	100~150	1	150	×
PA.18	Reserved	150	1	150	×
PA.19	Reserved	0~2	1	0	×
PF Group: Factory function parameter					
PF.00 ~ PF.10	Reserved	---	---	---	---
B-Monitoring: function parameter					
b-00	Output freq	Present output freq	0.01Hz	----	*
b-01	Set freq.	Present set freq.	0.01Hz	----	*
b-02	Output voltage	Effective value of present output voltage	1V	----	*
b-03	Output current	Effective value of present output current	0.1A	----	*
b-04	Bus bar voltage	Present DC bus bar voltage	1V	----	*

Func Code	Name	Range	Min Unit	Factory Default	Modify
b-05	Module temperature	IGBT heat sink temperature	10C	----	*
b-06	Motor speed	Present motor speed	1r/min	----	*
b-07	Running time	One continuous running time	1H	----	*
b-08	Input/output terminal state	Input/output terminal state	----	----	*
b-09	Analog input VI	Analog input VI value	0.01V	----	*
b-10	Analog input CI	Analog input CI value	0.01V	----	*
b-11	External pulse input	External pulse width input value	1ms	----	*
b-12	Inverter rated current	Inverter rated current	0.1A	----	*
b-13	Inverter rated voltage	Inverter rated voltage	1V	----	*
b-14	Set pressure	Water supply control when the set pressure of the pipeline	0.001 Mpa	----	*
b-15	Feedback pressure	Water supply control feedback pipeline pressure	0.001 Mpa	----	*
b-16	No unit display	No unit display	1	----	*

Note :
Monitoring parameter input/output terminal state displayed as follow:

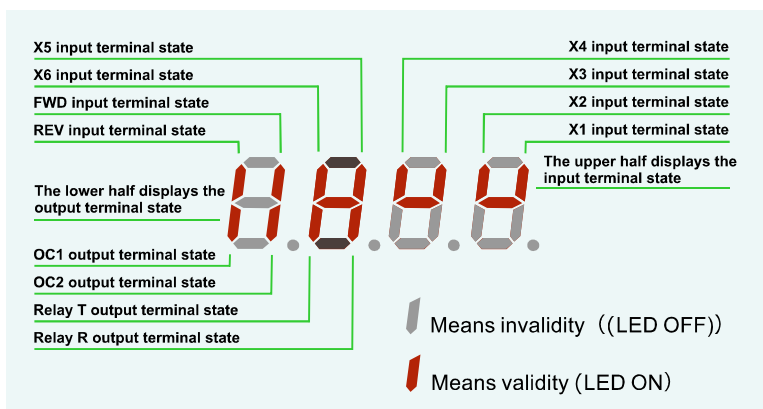

Chapter 6

Function Code Description

(P0 Group) Basic running function parameter.....	78
(P1 Group) Frequency Setting Function Parameter.....	86
(P2 Group) Start/Brake Function Parameter.....	88
(P3 Group) Auxiliary Running Parameter.....	91
(P4 Group) Terminal Control Function Parameter.....	100
(P5 Group) Protection Function Parameter.....	115
(P6 Group) Fault Record Function Parameter.....	119
(P7 Group) Close Loop Running Control Function Parameter.....	120
(P8 Group) PLC Running Parameter.....	129
(P9 Group) Swing Frequency Function Parameter.....	133
(PA Group) Vector Control Parameter.....	138
(PF Group) Factory Function Paramete.....	140

6.1 Basic running function parameter (P0 Group)

Func Code	Name	Range	Min Unit	Factory Default	Modify
P0.00	Control mode selection	0 : V/F Control 1 : Senseless vector control	1	0	○

0 : V/F Control

1 : Sensorless vector control

Func Code	Name	Range	Min Unit	Factory Default	Modify
P0.01	Control mode selection	0~8	1	0	○

0: Analog potentiometer given on control panel;

1: Control panel▲, ▼ key given. Use ▲, ▼ key to set running frequency;

2: Control panel frequency digital setting. Use control panel to amend P0.02 parameter (initial set freq.) to change set freq.;

3: Terminal UP/DOWN digital setting. Use terminal UP/DOWN to amend P0.02 parameter (initial set freq.) to change set freq.;

4: Serial port digital setting. (Remote control mode) Set P0.02 parameter (initial set freq.) via serial port;

5: VI analog given (VI-GND). Set freq. controlled by VI terminal analog input voltage. The voltage range is DC 0~10V. The corresponding relationship between set freq. and VI input voltage defined by function code P1.00~P1.05;

6: CI analog given (CI-GND). Set freq. controlled by CI terminal analog input voltage/current. The input voltage range is DC 0~10V (JP3 jumper V), and the current range is DC 4~20mA (JP3 jumper A). The corresponding relationship between set freq. and CI input defined by function code P.1.06~P1.10

7: Pulse terminal given. Set freq. controlled by terminal pulse (The pulse signal only can be input through X4 terminal.). The corresponding relationship between set freq. and input pulse defined by function code P1.11~P1.15.

8: Combination given (refer to function parameter P3.00).

Func Code	Name	Range	Min Unit	Factory Default	Modify
P0.02	Running frequency set	P0.19lower limit freq.~P0.20upper limit freq.	0.01HZ	50.00HZ	○

When Freq control channel selection setting (P0.01=1, 2, 3, 4), P0.02 parameter defines the initial digital set frequency.

Func Code	Name	Range	Min Unit	Factory Default	Modify
P0.03	Running command mode selection	0~2	1	0	○

0: Use control panel key RUN, STOP/RESET, JOG to operate the inverter.

1: Terminal control mode. Use control terminal FWD, REV, X1~X6, etc. to operate the inverter.

2: Serial port control mode. Operate the inverter via serial port RS485 in remote control mode.

Note:

Running command mode can be switched by changing P0.03 parameter in stopping or running state. Please use this function in caution.

Func Code	Name	Range	Min Unit	Factory Default	Modify
P0.04	Running direction setting	00~11	1	0	○

Running direction setting	
LED unit's digit	0 : Running forward 1 : Running reverse
LED ten's digit	0 : Reverse allowed 1 : Reverse prohibited

Func Code	Name	Range	Min Unit	Factory Default	Modify
P0.05	FWD/REV dead time	0.0~120.0s	0.1s	0.1s	○

In switching process between forward and reverse running, the transition time as Fig.6-1 t1 is defined as FWD/REV dead time. The inverter outputs 0 freq. during transition time.

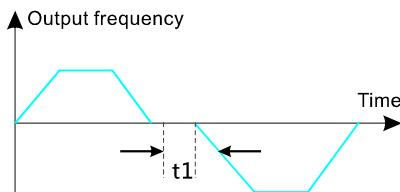

Fig.6-1 FWD/REV dead time

Func Code	Name	Range	Min Unit	Factory Default	Modify
P0.06	Max output freq.	50.00Hz~500.00Hz	0.01HZ	50.00HZ	×
P0.07	Basic running freq	1.00Hz~500.00Hz	0.01HZ	50.00HZ	×
P0.08	Max output voltage	1~480V	1V	inverter rated voltage	×

Max. output freq. is inverter highest output frequency allowed shown as Fig. 6-2 Fax.

Basic running freq. is the lowest output frequency corresponding to the highest output voltage of inverter. Generally, it is motor rated frequency shown as Fig.6-2 FB.

Max. output voltage is the output voltage corresponding to inverter outputs basic running frequency. Generally, it is motor rated voltage shown as Fig.6-2 Amax.

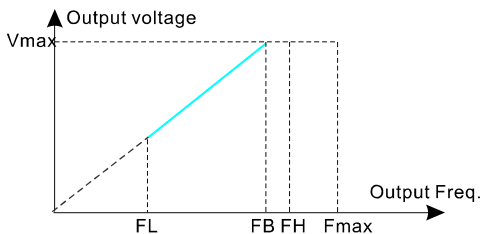

Fig.6-2 Fmax/FB/Vmax0V

Func Code	Name	Range	Min Unit	Factory Default	Modify
P0.09	Torque boost	0.0%~30.0%	0.1%	2.0%	×

In order to compensate the low frequency torque, boost the output voltage in the low frequency zone shown as Fig.6-3.

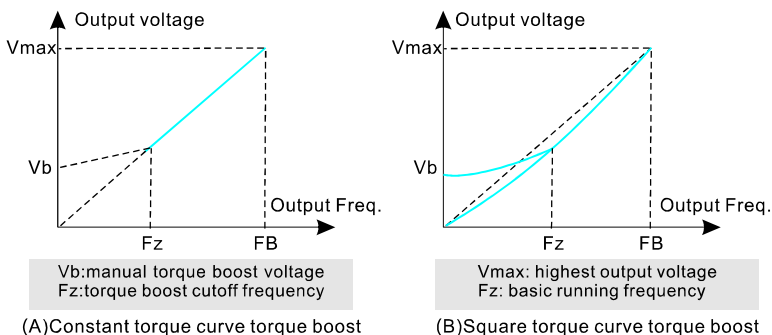

Fig.6-3 Torque boost

Func Code	Name	Range	Min Unit	Factory Default	Modify
P0.10	Torque boost cut-off freq.	0.00Hz~Basic running freq.P0.07	0.00	50.00Hz	○

This function defines the cutoff freq. in manual torque boost shown as Fig.6-3 Fz. This parameter is adaptable to any V/F mode defined by P0.22.

Func Code	Name	Range	Min Unit	Factory Default	Modify
P0.11	Torque boost mode	0~1	1	0	○

0: Manual boost. In manual boost mode, torque boost voltage is defined by P0.09 parameter, which is fixed. But the motor is easy to reach magnetic saturation in light-load.

1: Auto. boost. In this mode, torque boost voltage changes according to motor stator current changing. The higher of stator current, the bigger of boost voltage reaches.

$$\text{Boost voltage} = \frac{0.09}{100} \times \text{Motor rated voltage} \times \frac{\text{Inverter output current}}{2 \times \text{Inverter rated current}}$$

Func Code	Name	Range	Min Unit	Factory Default	Modify
P0.12	Carrier freq	1.0K~14.0K	0.1K	8.0K	×

The carrier freq. mainly affects the noise of motor and heat loss. The relationship between carrier freq. and motor noise, leakage current, and interference shown as follow.

Carrier Freq.	Decrease	Increase
Noise	↑	↓
Leakage Current	↓	↑
Interference	↓	↑

Note:

- ✦ In order to get better control characteristic, the ratio of carrier frequency to inverter highest running frequency is suggested beyond 36.
- ✦ Difference may occur in current value display, when carrier freq. is low.

Func Code	Name	Range	Min Unit	Factory Default	Modify
P0.13	Acc/Dec mode selection	0~1	1	0	×

0: Linear Acc/Dec. Output frequency increases or decreases as constant slope shown as Fig.6-4.

1: S curve Acc/Dec. Output frequency increases or decreases as s curve shown as Fig.6-5.

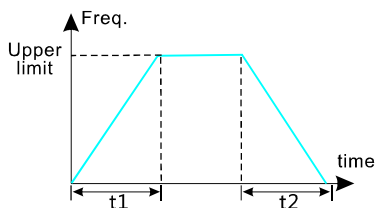

Fig.6-4 Linear Acc/Dec

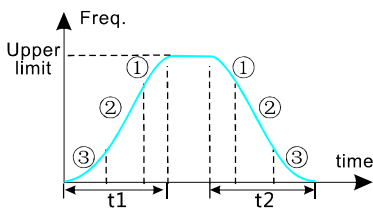

Fig.6-5 S curve Acc/Dec

Func Code	Name	Range	Min Unit	Factory Default	Modify
P0.14	Time of S curve start stage	10.0%~50.0% (Acc/Dec time)	0.1%	20.0%	○
P0.15	Time of S curve ascent stage	10.0%~80.0% (Acc/Dec time)	0.1%	60.0%	○

P0.14, P0.15 is effective only in s curve Acc/Dec mode(P0.13=1).

S curve start stage time shown as Fig.6-5(3). The curve slope is increasing from 0.

S curve ascent stage time shown as Fig.6-5(2). The curve slope keeps constant.

S curve end stage time shown as Fig.6-5(1). The curve slope is decreasing to 0.

Note:

- ✦ S curve Acc/Dec mode is suitable for the starting and stopping process of conveying load such as elevator and belt conveyor, etc.

Func Code	Name	Range	Min Unit	Factory Default	Modify
P0.16	Acc/Dec time unit	0~1	0	0	×

0: Second

1: Minute

Note:

- ✦ This function is effective for all Acc/Dec process except for JOG running mode.
- ✦ Please try to select second as time unit.

Func Code	Name	Range	Min Unit	Factory Default	Modify
P0.17	Acc time 1	0.1~6000.0	0.1	20.0	○
P0.18	Dec time 1	0.1~6000.0	0.1	20.0	○

Acc time is the time of inverter output frequency increasing from 0 to upper limit freq. shown as in Fig.6-6 t1.

Dec time is the time of inverter output frequency decreasing from upper limit freq. to 0 shown as Fig.6-6 t2.

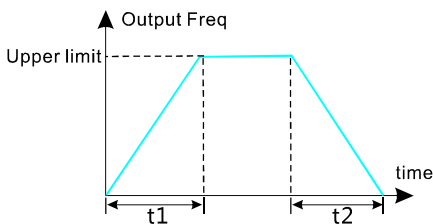

Fig.6-6 Acc/Dec time

Note:

- ✦ The inverter has 7 Acc/Dec time. Herein just 1 Acc/Dec is defined. The other 2~7 Acc/Dec time are defined by P3.14~P3.25 function parameter.
- ✦ It can select time unit by P0.09 for all 1~7 Acc/Dec time. The factory default setting unit is second.

Func Code	Name	Range	Min Unit	Factory Default	Modify
P0.19	Upper limit freq.	Lower limit freq. ~Max output freq.P0.06	0.01Hz	50.00Hz	×
P0.20	Lower limit freq.	0.00Hz~Upper limit freq.	0.01Hz	0.00Hz	×
P0.21	Lower limit freq. Running mode	0~1	1	0	×

P0.19,P0.20 parameter defines the upper and lower limit of output frequency. FH,FL is upper limit frequency and lower limit frequency respectively shown as Fig.6-2.

When actual setting frequency is lower than lower limit freq., the inverter output frequency will decrease in Dec time which has been set. As it reaches the lower limit frequency, if P0.21=0 , the inverter will run at lower limit frequency. If P0.21=1, the inverter will keep decreasing the output frequency to 0.

Func Code	Name	Range	Min Unit	Factory Default	Modify
P0.22	V/F curve setting	0~4	1	0	×
P0.23	V/F Freq.valueP3	P0.25~P0.07 Basic running freq.	0.01Hz	0.00Hz	×
P0.24	V/F Volt.valueV3	P0.26~100.0%	0.1%	0.0%	×
P0.25	V/F Freq.valueP2	P0.27~P0.23	0.01Hz	0.00Hz	×
P0.26	V/F Volt.valueV2	P0.28~P0.24	0.1%	0.0%	×
P0.27	V/F Freq.valueP1	0.00~P0.25	0.01Hz	0.00Hz	×
P0.28	V/F Volt.valueV1	0~P0.26	0.1%	0.0%	×

These function parameter defines flexible V/F setting mode of inverter. User can select 4 fixed curves and 1 customized curve through P0.22 parameter so as to meet different load requirements.

P0.22=0, Constant torque V/F curve shown as Fig.6-7 curve 0

P0.22=1, 1.2 times the power reduced torque V/F curve shown as Fig.6-7 curve 1

P0.22=2, 1.7 times the power reduced torque V/F curve shown as Fig.6-7 curve 2

P0.22=3, 2.0 times the power reduced torque V/F curve shown as Fig.6-7 curve 3

When inverter drives reduced torque load such as fans, and pumps, user can select 1/2/3 V/F curve running mode according to load characteristic for energy saving.

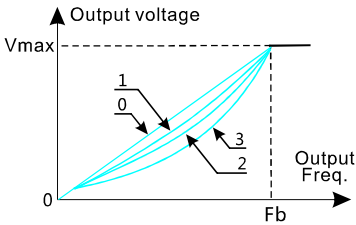

Vmax : max output voltage
Fb basic running Freq.

Fig 6-7 V/Curve

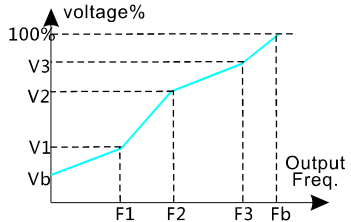

V1~V3: Multi-segment V / F 1st to 3rd
segment voltage percentage;
F1~F3: Multi-segment V / F 1st to 3rd
frequency points

Fig 6-8 customized V/Fcurve

P0.22=4, Customized V/F curve shown as Fig. 6-8.

User can define V/F curve through revising (V1,F1),(V2,F2),(V3,F3) so as to meet special load requirements. Torque boost is available for customized curve.

6.2 Frequency Setting Function Parameter (P1 Group)

Func Code	Name	Range	Min Unit	Factory Default	Modify
P1.00	Analog filtering time constant	0.01~30.00s	0.01s	0.20s	○

When adopts frequency external analog channel setting mode, time constant is inverter filtering sampling value time. When long distance wiring or serious interference cause setting frequency unstable, increase this time constant to avoid the disoperation. The longer filtering time, anti-interference ability will be stronger. But the response will be slower. The shorter filtering time it has, the quicker response, but weaker anti-interference ability.

Func Code	Name	Range	Min Unit	Factory Default	Modify
P1.01	VI channel gains	0.01~9.99	0.01	1.00	○
P1.02	VI min given	0.00~P1.04	0.01Hz	0.00V	○
P1.03	Corresponding freq. to VI min given	0.00~Upper limit freq.	0.01Hz	0.00Hz	○
P1.04	VI max given	P1.04~10.00V	0.01V	10.00V	○
P1.05	Corresponding freq.	0.00~Upper limit freq.	0.01Hz	50.00Hz	○
P1.06	CI channel gains	0.01~9.99	0.01	1.00	○
P1.07	CI min given	0.00~P1.09	0.01V	0.00V	○
P1.08	Corresponding freq. to CI min given	0.00~Upper limit freq	0.01Hz	0.00Hz	○
P1.09	CI max given	P1.07~10.00V	0.01V	10.00V	○
P1.10	Corresponding freq. to CI max given	0.00~Upper limit freq	0.01Hz	50.00Hz	○
P1.11	Max input pulse freq	0.1~20.0K	0.1K	10.0K	○
P1.12	Pulse min given	0.0~P1.14(Pulse max given)	0.1K	0.0K	○
P1.13	Corresponding freq. to pulse min given	0.00~Upper limit freq	0.01Hz	0.00Hz	○
P1.14	Pulse max given	P1.12(Pulse min given)~P1.11(Max input pulse freq.)	0.1K	0.1K	○
P1.15	Corresponding freq. to pulse max given	0.00~Upper limit freq	0.01Hz	50.00Hz	○

When selects VI, CI or pulse frequency input as open loop frequency setting channel, the relationship between frequency given and setting frequency as follow:

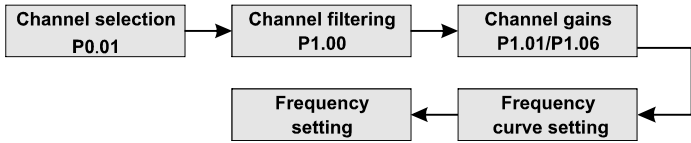

The relationship between VI and setting frequency is as follow.

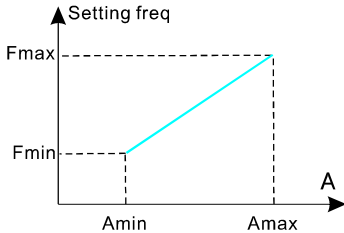

A : VI given Amin: Min
Amax: Max

(1) Positive effect

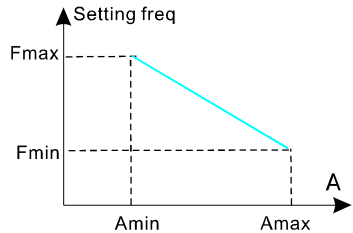

Pmin : corresponding Freq to Min given
Pmax : corresponding Freq to Max given

(2) Negative effect

The relationship between CI and setting frequency as follow.

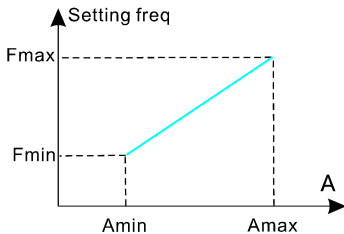

A : CI given Amin: Min
Amax: Max

(1) Positive effect

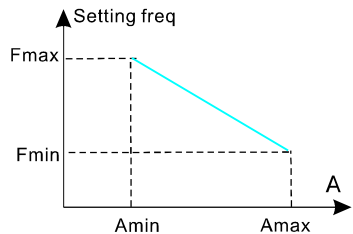

Pmin : corresponding Freq to Min given
Pmax : corresponding Freq to Max given

(2) Negative effect

The relationship between input PULSE frequency and setting frequency is as follow.

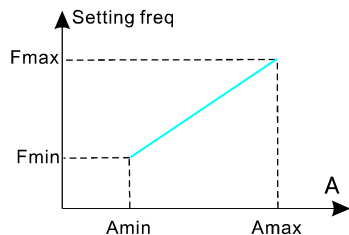

A : PLUSE given
 Amin: Min
 Amax: Max

(1) Positive effect

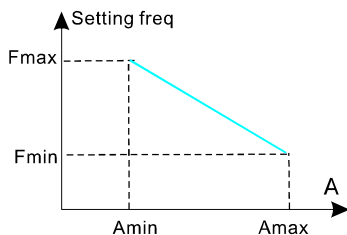

Pmin : corresponding Freq to Min given
 Pmax: corresponding Freq to Max given

(2) Negative effect

6.3 Start/Brake Function Parameter (P2 Group)

Func Code	Name	Range	Min Unit	Factory Default	Modify
P2.00	Start running mode	0~2	1	0	x

0 : The inverter starts from start freq.(P2.01) and keeps running at start freq. for duration defined as start freq. running duration (P2.02);

1 : The inverter brakes first by DC brake current (P2.03) and brake time (P2.04) ,and then starts from start frequency;

2 : The inverter restarts again after speed tracking, which is available for power restored after momentary power failure and restart after fault reset.

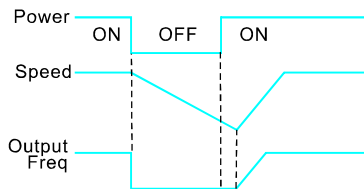

Fig.6-9 Speed tracking restart

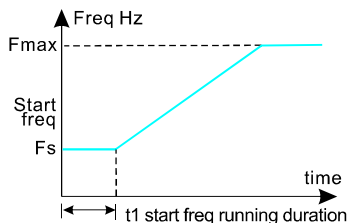

Fig.6-10 Start freq. and running duration

Note:

- ✦ Start running mode 0: It is suggested to use mode 0 in general applications and when to drive synchronous motor.
- ✦ Start running mode 1: It is suitable to small inertia loads which have FWD or REV running when there is no motor driven. But not suitable to big inertia loads.
- ✦ Start running mode 2: It is suitable to restart after momentary power failure and restart during motor free stopping.

Func Code	Name	Range	Min Unit	Factory Default	Modify
P2.01	Start freq.	0.40~20.00Hz	0.01Hz	0.50Hz	○
P2.02	Start freq. running duration	0.0~30.0s	0.1s	0.0s	○

Start freq. is the initial frequency when inverter starts shown as Fig.6-10 Fs. Start freq. running duration is the duration time for inverter keeping running at start frequency shown as Fig.6-10.

Note:

- ✦ Start frequency is not restricted by lower limit freq.

Func Code	Name	Range	Min Unit	Factory Default	Modify
P2.03	DC brake current as start	0~15%	1%	0%	○
P2.04	DC brake time as start	0.0~60.0s	0.1s	0.0s	○

DC brake current is a percentage relative to the inverter rated current. There is no DC brake as DC brake time is 0.0s.

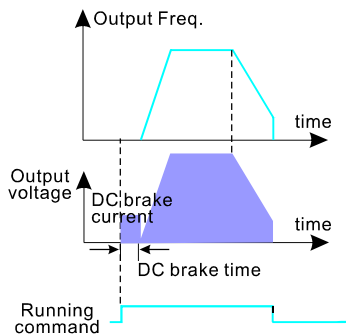

Fig.6-11 start mode 1

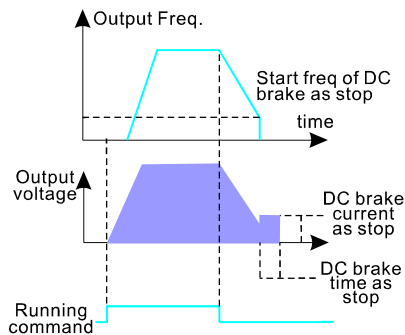

Fig.6-12 DC stop and DC brake

Func Code	Name	Range	Min Unit	Factory Default	Modify
P2.05	Stop mode	0~2	1	0	×

0: After receiving stop command, the inverter decreases the output frequency to 0 in set Dec time.

1: After receiving stop command, the inverter stops output immediately, and the load goes to stop by mechanical inertia. This is called as coast stop.

2: After receiving stop command, the inverter decreases the output frequency in Dec time , when it reaches the start frequency of DC brake, the inverter begins to DC brake.

Func Code	Name	Range	Min Unit	Factory Default	Modify
P2.06	Start freq. of DC brake as stop	0.0~15.00Hz	0.0Hz	3.00Hz	○
P2.07	DC brake time as stop	0.0~60.0s	0.1s	0.0s	○
P2.08	DC brake current as stop	0~15%	1%	0%	○

DC brake current as stop is a percentage relative to the inverter rated current. There is no DC brake when DC brake time is 0.0s.

6.4 Auxiliary Running Parameter ((P3 Group)

Func Code	Name	Range	Min Unit	Factory Default	Modify
P3.00	Freq. control channel combination	0~20	1	0	×

As P0.01(frequency control channel selection)=8, It can set frequency control channel combination through the above parameter (P3.00).

0 : VI+CI;

1 : VI-CI;

2 : external pulse given +V1+ control panel▲、▼key given;

3 : external pulse given +V1+ control panel▲、▼key given;

4 : external pulse given +CI;

5 : external pulse given -CI;

6 : RS485 given +VI + control panel ▲、▼key given ;

7 : RS485 given -VI - control panel ▲、▼key given;

8 : RS485given +CI+ control panel ▲、▼key given;

9 : RS485given -CI-control panel ▲、▼key given;

10 : RS485given +CI+ external pulse given;

11 : RS485given -CI- external pulse given;

12 : RS485 given +VI+ external pulse given;

13 : RS485 given -VI- external pulse given;

14 : VI + CI + control panel▲、▼key given + digital given P0.02;

15 : VI + CI - control panel▲、▼key given + digital given P0.02;

16 : MAX (VI , CI) ;

17 : MIN (VI , CI) ;

18 : MAX (VI , CI , PLUSE) ;

19 : MIN (VI , CI , PLUSE) ;

20 : VI , CI availability except , VI prior;

21: VI+Terminal UP/ DOWN;

22: CI+Terminal UP/ DOWN.

Func Code	Name	Range	Min Unit	Factory Default	Modify
P3.01	Parameter initialization setting	LED unit's digit 0~2 LED ten's digit 0~2	1	0	×

0: After receiving stop command, the inverter decreases the output frequency to 0 in set Dec time.

1: After receiving stop command, the inverter stops output immediately, and the load goes to stop by mechanical inertia. This is called as coast stop.

2: After receiving stop command, the inverter decreases the output frequency in Dec time , when it reaches the start frequency of DC brake, the inverter begins to DC brake.

Parameter initialization setting	
LED unit's digit	0 : All parameters are allowed to be revised 1 : All parameters are not allowed to be revised except this parameter itself 2 : All parameters are not allowed to be revised except P0.02 parameter and this parameter itself.
LED ten's digit	0 : inaction 1 : Factory default reset 2 : Clear history fault record

Note:

- + The factory default setting of this function code parameter is 0, that is all the function code parameter are allowed to be revised .
- + After factory default reset, each place of this function code recovers to 0 automatically.

Func Code	Name	Range	Min Unit	Factory Default	Modify
P3.02	Parameter copy	0~2	1	0	×

0 : inaction;

1 : Parameter upload: upload function code parameter to remote control;

2 : Parameters download: download function code parameter from remote control.

Note:

- + This feature is only available for the remote control. Parameters are automatically restored to 0 after executing upload or download.

Func Code	Name	Range	Min Unit	Factory Default	Modify
P3.03	Auto energy save running	0~1	1	0	×

0 : inaction

1 : action

When motor is running with light load or no-load, the inverter will detect the load current and adjust output voltage appropriately so as to save energy. This function is mainly used in application with stable load and running speed.

Func Code	Name	Range	Min Unit	Factory Default	Modify
P3.04	AVR function	0~20	1	0	×

0 : inaction

1 : always action

2 : inaction only in deceleration

This is auto voltage regulation function. When inverter input voltage is fluctuating, use this function to keep inverter output voltage stable.

When inverter is decelerating to stop, if AVR function is invalid, the Dec. Time is going to be shorter. But it will output a higher running current. If AVR is effective, the motor will be decelerating stably with lower running current, but the Dec. Time becomes longer.

Func Code	Name	Range	Min Unit	Factory Default	Modify
P3.05	Slip freq. compensation	0~150%	1%	0%	×

This function can regulate the output frequency appropriately according to the load, which can dynamically compensate the slip frequency of asynchronous motor so as to control the speed at a stable value. If use this function in conjunction with auto. torque boost function, It can achieve better low speed torque characteristic, which is shown as Fig.6-13.

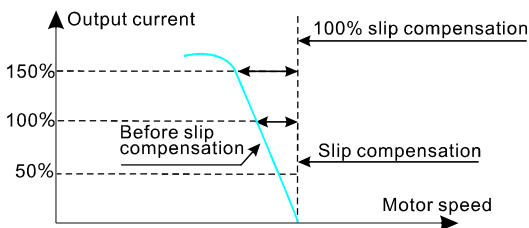

Fig.6-13 slip freq. compensation

Func Code	Name	Range	Min Unit	Factory Default	Modify
P3.06	JOG running freq.	0.10~50.00Hz	0.01Hz	5.00Hz	○
P3.07	JOG Acc time	0.1~60.0s	0.1s	20.0s	○
P3.08	JOG Dec time	0.1~60.0s	0.1s	20.0s	○

JOG frequency has the highest priority. In any stage, as long as there is a JOG command input, the inverter will switch to JOG frequency running by JOG Acc/Dec time immediately, which is shown as Fig.6-14

JOG Acc time is the time for inverter accelerating from 0 to upper limit freq.

JOG Dec time is the time for inverter decelerating from upper limit freq. to 0.

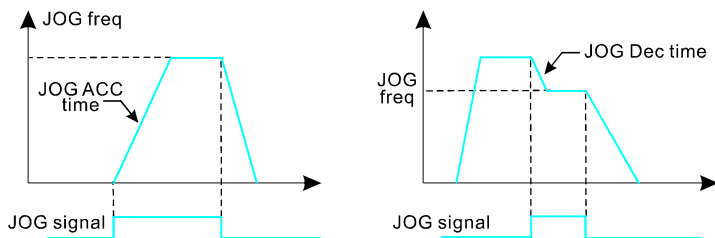

Fig.6-14 JOG running

Note:

- + JOG running is available in panel control mode, terminal and serial port control mode.
- + After JOG running command is canceled, the inverter will decelerate by Dec time.

Func Code	Name	Range	Min Unit	Factory Default	Modify
P3.09	Communication configuration	000~155	1	005	×

User can configure the baud rate, data format and communication mode by setting P3.09.

Communication configuration	
LED unit's digit (baud rate)	0 : 1200BPS 1 : 2400BPS 2 : 4800BPS 3 : 9600BPS 4 : 19200BPS 5 : 38400BPS
LED ten's digit (data format)	0 : 1-7-2 Format, without check : 1-initial place, 7-data place, 2-stop place, without check; 1 : 1-7-1 Format, odd parity check : 1-initial place, 7-data place, 1-stop place, odd parity check; 2 : 1-7-1 Format, even parity check : 1-initial place, 7-data place, 1-stop place, even parity check;

Communication configuration	
LED ten's digit (data format)	3 : 1-8-2 Format, without check : 1-initial place, 8-data place, 2-stop place, without check ; 4 : 1-8-1 Format, odd parity check : 1-initial place, 8-data place, 1-stop place, odd parity check ; 5 : 1-8-1 Format, even parity check : 1-initial place, 8-data place, 1-stop place, even parity check ; 6 : 1-8-1 Format, even parity check : 1-initial place, 8-data place, 1-stop place, without check ;
LED hundred's digit (communication mode)	0: MODBUS · ASCII Mode: MODBUS communication protocol, ASCII data transmission ; 1: MODBUS · RTU Mode: MODBUS communication protocol, RTU data transmission.

Func Code	Name	Range	Min Unit	Factory Default	Modify
P3.10	Local address	0~248	1	1	×

This function is used to mark the address of inverter itself in serial port communication mode.

0 Broadcast address. When the inverter works as a slave, if it receives address command as 0, it means the inverter is receiving broadcast command and unnecessary to respond the host.

248 Host address. When the inverter works as a host, set P3.10=248, the host inverter is able to send broadcast command to other slave inverters so as to achieve multi-machine interaction.

Func Code	Name	Range	Min Unit	Factory Default	Modify
P3.11	Communication overtime detection time	0.0~1000.0S	0.1s	0.0s	×

When serial port communication is failed, if the duration exceeds the set value of this function, the inverter will conclude that there is a communication failure.

As set value is 0, the inverter will not detect the serial port communication signal, that this function is invalid.

Func Code	Name	Range	Min Unit	Factory Default	Modify
P3.12	Local response delay	0~1000ms	1s	5ms	×

Local response delay is the time from serial port receiving the command from the upper computer and executing the command to responding the upper computer.

Func Code	Name	Range	Min Unit	Factory Default	Modify
P3.13	Multi-running proportion	0.01~1.00	0.01	1.00	×

This function code is used to set the scale factor of inverter received frequency set command through serial port. The actual inverter running frequency is equal to this scale factor multiplied by received frequency set command through serial port.

In multi-machine interaction running mode, it can use this parameter to set the scale of multi-inverter running frequency. That is different running freq.

Func Code	Name	Range	Min Unit	Factory Default	Modify
P3.14	Acc time2	0.1~6000.0	0.1	20.0	○
P3.15	Dec time2	0.1~6000.0	0.1	20.0	○
P3.16	Acc time3	0.1~6000.0	0.1	20.0	○
P3.17	Dec time3	0.1~6000.0	0.1	20.0	○
P3.18	Acc time4	0.1~6000.0	0.1	20.0	○
P3.19	Dec time4	0.1~6000.0	0.1	20.0	○
P3.20	Acc time5	0.1~6000.0	0.1	20.0	○
P3.21	Dec time5	0.1~6000.0	0.1	20.0	○
P3.22	Acc time6	0.1~6000.0	0.1	20.0	○
P3.23	Dec time6	0.1~6000.0	0.1	20.0	○
P3.24	Acc time7	0.1~6000.0	0.1	20.0	○
P3.25	Dec time7	0.1~6000.0	0.1	20.0	○

This function can define seven kinds of Acc/Dec time. It can select 1~7 kind of Acc/Dec time during running process by different combination of control terminal (Please refer to P4.00~P4.05).

Func Code	Name	Range	Min Unit	Factory Default	Modify
P3.26	Multi-stage freq.1	Multi-stage freq.1	0.01Hz	5.00Hz	○
P3.27	Multi-stage freq.2	Multi-stage freq.2	0.01Hz	10.00Hz	○
P3.28	Multi-stage freq.3	Multi-stage freq.3	0.01Hz	20.00Hz	○

Func Code	Name	Range	Min Unit	Factory Default	Modify
P3.29	Multi-stage freq.4	Multi-stage freq.4	0.01Hz	30.00Hz	○
P3.30	Multi-stage freq.5	Multi-stage freq.5	0.01Hz	40.00Hz	○
P3.31	Multi-stage freq.6	Multi-stage freq.6	0.01Hz	45.00Hz	○
P3.32	Multi-stage freq.7	Multi-stage freq.7	0.01Hz	50.00Hz	○

These setting frequency can be used in multi-stage speed running mode and PLC simple running mode (please refer to P.00~P4.05 and P8 group).

Func Code	Name	Range	Min Unit	Factory Default	Modify
P3.33	Jump freq.1	0.00~500.00Hz	0.01Hz	0.00Hz	×
P3.34	Jump freq.1range	0.00~30.00Hz	0.01Hz	0.00Hz	×
P3.35	Jump freq.2	0.00~500.00Hz	0.01Hz	0.00Hz	×
P3.36	Jump freq.2range	0.00~30.00Hz	0.01Hz	0.00Hz	×

This function is used for the inverter to avoid the resonance frequency of mechanical load.

The inverter setting frequency is able to do jump running near some frequency point shown as Fig.6-14. It can set 3 jump ranges at most.

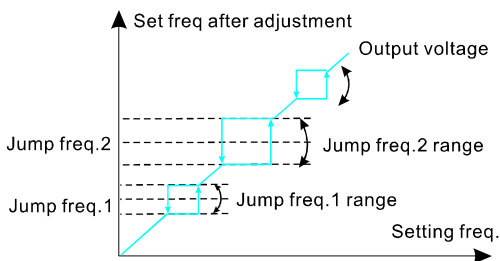

Fig.6-15 Jump frequency and range

Func Code	Name	Range	Min Unit	Factory Default	Modify
P3.37	Reserved	0000~9999	1	0000	×
P3.38	Zero frequency DC braking voltage	0.0%~15.0%	0.1%	0.0%	×

DC brake at 0 freq means inverter output DC voltage to brake motor while freq is 0. Users can adjust P3.38 to get larger braking force, but the current will be larger.

Func Code	Name	Range	Min Unit	Factory Default	Modify
P3.39	Set running time	0~65.535K hour	0.001K	0.000K	○
P3.40	Total running	0~65.535K hour	0.001K	0.000K	○

As total running time reaches set running time, the inverter will output index signal (refer to P4.08~P4.09).

P3.40 function code defines the total running time of inverter from factory delivery to present.

Func Code	Name	Range	Min Unit	Factory Default	Modify
P3.41	Inspection speed start wait time	00.0~60.0	0.1s	2.0 s	○

P3.41 is used for setting waiting time for restart at 0 freq. when restart failed, adjusting the parameter to restart.

Func Code	Name	Range	Min Unit	Factory Default	Modify
P3.42	Inspection speed and start the	00.0~150.0%	0.1%	100.0%	○

P3.42 is used to limit the maximum output current of restart for protection.

Func Code	Name	Range	Min Unit	Factory Default	Modify
P3.43	Running display parameter selection1	00~15	1	00	○

This function is used for LED displayed parameter when inverter running. 0-15 relate to monitoring parameter b-01 to b-15. For example, output current will displayed on LED when setting P3.43=03. Users can monitor other parameters by pressing **▶▶** key.

Func Code	Name	Range	Min Unit	Factory Default	Modify
P3.44	Stop display parameter selection2	00~15	1	00	○

This function is used for LED displayed parameter when inverter running. 0-15 relate to monitoring parameter b-01 to b-15. For example, output current will be displayed on LED when setting P3.44=03. Users can monitor other parameters by pressing ►► key.

Func Code	Name	Range	Min Unit	Factory Default	Modify
P3.45	No unit display coefficient	0.1~60.0	0.1	29.0	○

The function is used for proportional relationship of monitoring parameters b-06 and the output frequency;

$b-06 \text{ displayed value} = \text{output freq.} \times P3.45.$

Func Code	Name	Range	Min Unit	Factory Default	Modify
P3.46	JOG/REV Switching control	0~1	1	0	×

Select the JOG / REV key switching. Settings are as follows:

0 : JOG running mode

1 : REV running mode

6.5 Terminal Control Function Parameter (P4 Group)

Func Code	Name	Range	Min Unit	Factory Default	Modify
P4.00	Input terminal X1 function selection	0~30	1	0	×
P4.01	Input terminal X2 function selection	0~30	1	0	×
P4.02	Input terminal X3 function selection	0~30	1	0	×
P4.03	Input terminal X4 function selection	0~30	1	0	×
P4.04	Input terminal X5 function selection	0~30	1	0	×
P4.05	Input terminal X6 function selection	0~30	1	0	×
P4.06	Input terminal X7 function selection	0~30	1	0	×
P4.07	Input terminal X8 function selection	0~30	1	0	×
P4.08	Input terminal X1 function selection	0~30	1	0	×

The multifunctional input terminal X1~X8 provide various function. It can set the value of P4.00~P4.07 to define the function of terminal X1~X8 shown as Table 6-1. Terminal X7 -FWD terminal, X8 -REV terminal.

Table 6-1 Multifunctional input selection

content	function	content	function
0	Idle terminal	1	Multi-stage speed terminal 1
2	Multi-stage speed terminal 2	3	Multi-stage speed terminal 3
4	External FWD JOG control input	5	External REV JOG control input
6	Acc/Dec time terminal 1	7	Acc/Dec time terminal 2
8	Acc/Dec time terminal 3	9	3-wire control
10	Free stop input (FRS)	11	External stop command
12	Stopping DC brake input command DB	13	Inverter running prohibited
14	Freq. increase command(UP)	15	Freq. decrease command(DOWN)

content	function	content	function
16	Acc/Dec prohibited command	17	External reset input (clear fault)
18	Peripheral equipment fault input (normally open)	19	Freq. control channel selection 1
20	Freq. control channel selection 2	21	Freq. control channel selection 3
22	Command switched to terminal	23	Running command control mode selection 1
24	Running command control mode selection 2	25	Swing freq start mode selection
26	Swing freq running reset	27	Close loop invalid
28	Simple PLC running pause command	29	PLC invalid
30	PLC reset in stopping state	31	Freq. switched to CI
32	Counter trigger signal input	33	Counter clear input
34	External interrupt input	35	Pulse freq. input (only valid for X6)
36	Fire mode		

Description of function listed in Table 6-1:

1~3: Multi-stage speed control terminal

It can set 7-stage speed running frequency at most by selecting ON/OFF combination of these 3 control terminals and selecting Acc/Dec time at the same time shown as Table 6-2.

Table 6-2 Multi-stage speed running selection

K3	K2	K1	Freq. setting	Acc/Dec time
OFF	OFF	OFF	Normal running freq.	Acc/Dec time 1
OFF	OFF	ON	Multi-stage freq.1	Acc/Dec time 1
OFF	ON	OFF	Multi-stage freq.2	Acc/Dec time 2
OFF	ON	ON	Multi-stage freq.3	Acc/Dec time 3
ON	OFF	OFF	Multi-stage freq.4	Acc/Dec time 4
ON	OFF	ON	Multi-stage freq.5	Acc/Dec time 5
ON	ON	OFF	Multi-stage freq.6	Acc/Dec time 6
ON	ON	ON	Multi-stage freq.7	Acc/Dec time 7

The above multi-stage frequency can be used in multi-stage speed running mode and simple PLC running mode. Herein take multi-stage speed running for example as follow.

Define control terminal X1, X2, X3 as follow.

P4.00=1, P4.01=2, P4.03=3, that X1, X2, X3 are used to achieve multi-stage speed running shown as Fig.6-18.

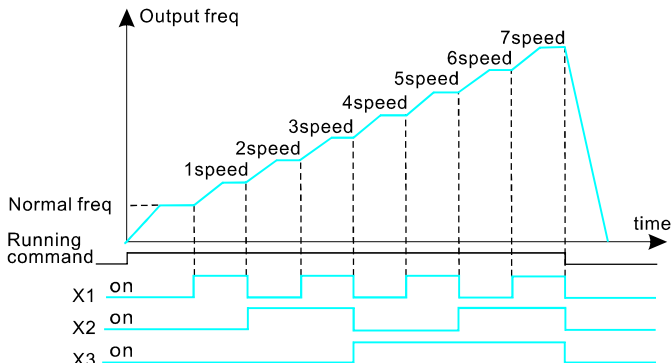

Fig 6-16 multi-stage speed running

Take terminal control mode for example as Fig.6-19, that K7,K8 can control forward or reverse running.

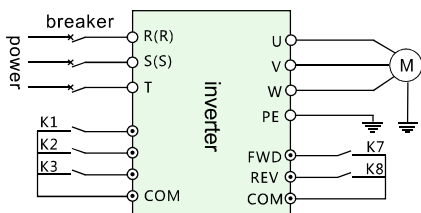

Fig.6-17 wiring diagram of multi-stage speed running

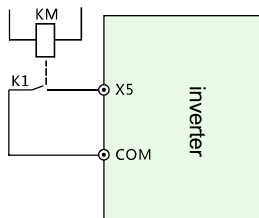

Fig.6-18 peripheral equipment

4~5: External JOG control input JOGP/JOGR.

In terminal control mode(P0.03=1), JOGP is JOG forward running, JOGR is JOG reverse running. JOG running frequency and JOG running Acc/Dec time is defined by P3.06~P3.08.

6~8 : Acc/Dec time terminal selection.

Table 6-3 Acc/Dec time terminal selection logical mode

Terminal 3	Terminal 2	Terminal 1	Acc/Dec time selection
OFF	OFF	OFF	Acc time1 / Dec time 1
OFF	OFF	ON	Acc time2 / Dec time 2
OFF	ON	OFF	Acc time3 / Dec time 3
OFF	ON	ON	Acc time4 / Dec time 4
ON	OFF	OFF	Acc time5 / Dec time 5
ON	OFF	ON	Acc time6 / Dec time 6
ON	ON	OFF	Acc time7 / Dec time 7

By ON/OFF combination of Acc/Dec time terminal the Acc/Dec time 1~7 can be selected accordingly.

9 : 3-wire control. Please refer to P4.08.

10 : Free stop input (FRS). This function is same as free stop defined by P2.05. But this is controlled by terminal which is convenient for remote control.

11 : External stop command. This command is effective in all running command control mode.

12 : Stopping DC brake input command DB. Use control terminal to execute DC brake to the motor during stop process in order to achieve motor emergency stop and accurate positioning. Brake start frequency, brake current, and brake time are defined by P2.06~P2.08.

13 : Inverter running prohibited. When this terminal is effective, the inverter in running state will go to stop, and the inverter in stopping state will be prohibited to start. This function is mainly used in application requiring safety linkage.

14~ 15 : Freq. Increasing command (UP), Freq. decrease command (DOWN). The frequency increase or decrease is controlled by control terminal. It can take the place of control panel in remote control mode.

16 : Acc/Dec prohibited command. To maintain the motor free from influence of any input command except stopping command, and keep running at the present speed.

Note: Function invalid at normal Dec stop process.

17 : External reset input(clear fault). When there is a fault alarm, it can reset the inverter by this terminal. This function is same as ENTER/DATA key in control panel.

18 : Peripheral equipment fault input(normally open). The peripheral equipment fault can be input by this terminal for the convenience of inverter to monitor the peripheral equipment. The inverter will display'E-13', that is peripheral equipment fault alarm, after receiving peripheral equipment fault signal.

19~ 21 : Freq. Control channel selection. The freq. control channel can be switchable by the ON/OFF combination of these 3 control terminals shown as Table 6-4. For this function and P0.01 defined function, the later set one is prior to previous one.

Table 6-4 Freq. control channel selection logical mode

Freq. control channel selection	Freq. control channel selection	Freq. control channel selection	frequency control channel selection
OFF	OFF	OFF	Maintaining set Freq.
OFF	OFF	ON	Function code digital given
OFF	ON	OFF	Terminal UP/DOWN given
OFF	ON	ON	Serial port given
ON	OFF	OFF	VI
ON	OFF	ON	CI
ON	ON	OFF	PULSE
ON	ON	ON	Combination given(refer to P3.01)

22 : Command switched to terminal. As this function is effective, the running control mode will be switched to terminal control mode.

23~24 : Running control mode selection

The running control mode can be switchable by the ON/OFF combination of these 2 control terminals shown as Table 6-5. For this function and P0.03 defined function, the later set one is prior to previous one.

Table6-5 running control mode selection logical mode

Running control mode selection 2	Running control mode selection 1	Running control mode selection
OFF	OFF	Maintaining running control mode
OFF	ON	Control panel control mode
ON	OFF	Terminal control mode
ON	ON	Terminal control mode

25 : Swing freq. start mode selection.

In swing frequency manual start mode, the swing frequency running will be effective as this terminal is effective (refer to P9 Group).

26 : Swing freq. running reset

In swing frequency running mode, no matter it is in manual or automatically start mode, by closing this terminal it will clear the recorded data of swing frequency running. The swing frequency running will restart by disconnecting this terminal. (Referring to P9 Group)

27 : Close loop invalid

In close loop running state, this function can invalidate the close loop running, and the inverter will switch to lower priority running mode.

Note:

- ✦ only in the closed-loop operation (P7.00 = 1) it can be switched between the closed-loop and low-level operating mode.

28 : Simple PLC running pause command

In simple PLC running state, as this function is effective, the PLC running will pause, and the inverter will run at 0 HZ. As this function is invalid, the inverter will automatically execute running speed tracking start and continue PLC running (refer to P8 Group).

29 : PLC invalid

In PLC running state, this function can invalidate the PLC running, and the inverter will switch to lower priority running mode.

30 : PLC reset in stopping state

In the stopping state of PLC running mode, as this terminal is effective, the inverter will clear the data recorded in stopping state, such as PLC running stage, running time, and running frequency, etc. (refer to P8 Group).

31 : Freq. Switched to CI

When this function is effective, the frequency control channel will be switched to CI given.

32 : Counter trigger signal input

There is a built-in counter in inverter, the max input pulse frequency to pulse input port is 200Hz. It can store memory the present counted data when power failure (refer to P4.21, P4.22).

33 : Counter clear input

Clear the built-in counter to 0.

34 : External interrupt input

In the running state, when inverter receives external interrupt signal, it will stop output, and run at zero frequency. After the interrupt signal is cancelled, the inverter will execute automatically the running speed tracking start mode, and continue to run again.

35 : Pulse freq. input

Only valid for X4 terminal. This terminal receives pulse signal as frequency given command (refer to P1.11~P1.15).

36: Fire mode

Inverters ignore the control signal or alarm in the fire mode. It will be possible to extend the reliable running time until it is damaged to ensure a safe evacuation in a smoke-free environment.

Func Code	Name	Range	Min Unit	Factory Default	Modify
P4.08	FWD/Rerunning mode selection	0~4	1	0	×

4 control modes:

0 : 2-wire control mode 1

K2	K1	Command
0	0	Stop
0	1	FWD
1	0	REV
1	1	Stop

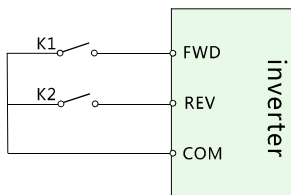

Fig.6-19 2-wire control mode1

1 : 2-wire control mode 2

K2	K1	Command
0	0	Stop
1	0	Stop
0	1	FWD
1	1	REV

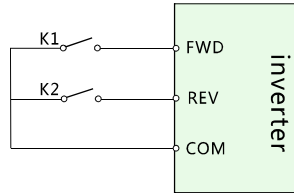

Fig.6-20 2-wire control mode 2

2 : 3-wire control mode 1

Xi is one of multifunctional input terminal X1~X6 which should be defined to function 9, that is 3-wire control mode.

- SB1 : STOP
- SB2 : FWD
- SB3 : REV

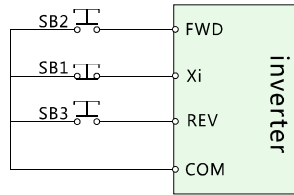

Fig.6-21 3-wire control mode 1

3 : 3-wire control mode 2

Xi is one of multifunctional input terminal X1~X6 which should be defined to function 9, that is 3-wire control mode.

K2	Command
0	FWD
1	REV

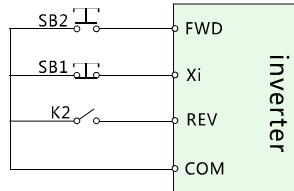

Fig.6-22 3-wire control mode 2

Note:

- ✦ In alarm stopping mode, if the running control mode is selected as terminal control mode and FWD/REV terminal is effective, the inverter will start at once after fault reset.

Func Code	Name	Range	Min Unit	Factory Default	Modify
P4.09	UP/DN Rate	0.01-99.99Hz/s	0.01	1.00 Hz/s	○

This function code defines the rate of change of set frequency given by UP/DOWN terminal.

Func Code	Name	Range	Min Unit	Factory Default	Modify
P4.10	2-way open collector output terminal OC1 output selection	0~22	1	0	×
P4.11	2-way open collector output terminal OC2 output selection	0~22	1	0	×
P4.12	Relay TA/TB/TC output selection	0~22	1	0	×
P4.13	Relay RA/RB/RC output selection	0~22	1	0	×

OC1 Open collector output terminal · Table 6-6 is for function optional parameters.

Table 6-6 Output terminal function selection

content	function	content	function
0	Inverter is running(RUN)	1	Freq. arrival signal(FAR)
2	Freq. level detected signal(FDT1)	3	reversed
4	Overload pre-alarm signal (OL)	5	Under voltage locking (LU)
6	External faults stopping (EXT)	7	Output freq. upper limit (FH)
8	Output freq. lower limit (FL)	9	Inverter in 0 speed running
10	Simple PLC stage running finish	11	PLC running cycle finish
12	Set counts arrival	13	Specified counts arrival
14	Inverter ready for running (RDY)	15	Inverter fault
16	Start freq. running time	17	DC brake time when start

content	function	content	function
18	DC brake time when stop	19	Swing freq. upper/lower limit
20	Set running time arrival	21	Upper pressure alarm signal
22	Lower pressure alarm signal		

The description of function listed in Table 6-6 as follow.

0 : Inverter in running(RUN). In the running state, it outputs index signal.

1 : Freq. arrival signal(FAR). Please refer to P4.12.

2 : Freq. level detected signal(FDT1). Refer to P4.11~P4.12.

3 : reserved

4 : Overload pre-alarm signal(OL). As inverter output current exceeds P5.02 defined overload detected level and the time is longer than P5.03 defined overload detected time. It outputs index signal.

5 : Under voltage locking(LU). In the running state, when DC bus bar voltage is lower than limited level, the inverter will display 'E-11' and outputs index signal.

6 : External fault stopping(EXT). When external fault alarm occurs (E-13), it outputs index signal.

7 : Output freq. upper limit(FH). When set freq upper limit freq, and running frequency reaches upper limit freq, it outputs index signal.

8 : Output freq. lower limit(FL). When setting freq lower limit freq, and running frequency reaches lower limit frequency, it outputs index signal.

9 : Inverter in zero speed running. When the inverter outputs 0 HZ, but still in running state, it will outputs index signal.

10 : Simple PLC stage running finish. When present simple PLC stage finishes, it outputs index signal.(single pulse signal, width is 500ms).

11: A PLC running cycle finish. When a simple PLC running cycle finishes, it outputs index signal.(single pulse signal, width is 500ms).

12 : Set counts arrival.

13 : Specified counts arrival. (Refer to P4.21~P4.22)

14 : Inverter ready for running(RDY). When this signal outputs, it means the inverter bus bar voltage is normal, and the inverter running prohibited terminal is invalid, that inverter can start.

15 : Inverter fault. When fault occurs in the running state, it outputs index signal.

16 : Start freq. running time .

17 : DC brake time when start.

18 : DC brake time when stop.

19 : Swing freq. upper/lower limit. In swing frequency running mode, if the fluctuation range of swing frequency calculated according to center freq. exceeds upper limit freq.P0.19 or below lower limit freq.P0.20, it outputs index signal.

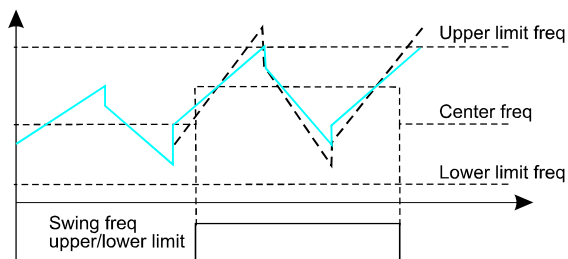

Fig.6-23 swing freq. upper/lower limit

20 : Set running time arrival. When inverter total running time (P3.40) reaches set running time (P3.39), it outputs index signal.

21: upper pressure alarm signal. On closed-loop control, Inverter output alarm signal when the pipeline pressure is greater than the upper limit of pressure.

22: Lower pressure alarm signal. On closed-loop control, Inverter output alarm signal when the pipeline pressure is lower than the lower limit of pressure.

Func Code	Name	Range	Min Unit	Factory Default	Modify
P4.14	Freq. arrival detection range	0.00~400.00Hz	0.01Hz	5.00Hz	×

This function is a complement to function 1 listed in Table 6-6. When inverter output frequency is in the “+ -” detection range of set frequency, it outputs pulse signal shown as Fig.6-24.

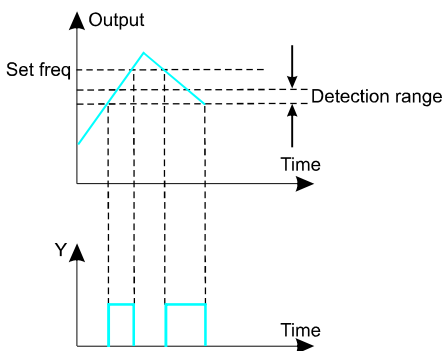

Fig.6-24 Freq. arrival detection range

Func Code	Name	Range	Min Unit	Factory Default	Modify
P4.15	Freq. arrival detection range	0.00~400.00Hz	0.01Hz	5.00Hz	×
P4.16	FDT1 lag	0.00~50.00Hz	0.01Hz	1.00Hz	○

P4.13~P4.14 are the complement to function 2 listed in Table 6-6. P4.15~P4.16 are the complement to function 3 listed in Table 6-6. Both are same in usage. For example, when output frequency exceeds a certain set frequency (FDT1), it outputs index signal until output frequency decreasing to a certain frequency lower than FDT1 (FDT1-FDT1 lag) shown as Fig.6-25.

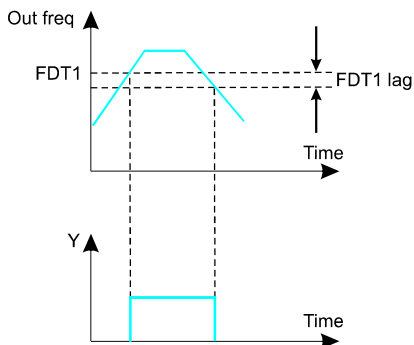

Fig.6-25 freq level detection

Func Code	Name	Range	Min Unit	Factory Default	Modify
P4.17	Analog output (Ao1) selection	0~7	01	00	○
P4.18	Analog	0.50~2.00	0.01	1.00	○
P4.19	Analog output (AO2) selection	0~7	01	00	○
P4.20	Analog output (AO2) gain	0.50~2.00	0.01	1.00	○

6-7 Output terminal indication

Content	Function	Indication range
0	Output freq.	0~limit freq
1	Output current	0-2×rated current
2	Output voltage	0-1.2×motor rated voltage
3	Bus bar voltage	0-800V
4	PID given	0~10V
5	PID feedback	0~10V
6	VI	0~10V
7	CI	0~10V/4~20mA

Ten' s content	Function	description
0	0~10V	Output voltage 0~10V
1	0~20mA	Output current 0~20mA , AO1jumper to 1
2	4~20mA	Output current 4~20mA , AO1 jumper to 1

As to AO analog output, if user wants to change measuring range or adjust meter tolerance, it can be achieved by regulating the output gain.

Func Code	Name	Range	Min Unit	Factory Default	Modify
P4.21	DO output terminal	0~7	0.01Hz	5.00Hz	○

Please refer to Table 6-7.

Func Code	Name	Range	Min Unit	Factory Default	Modify
P4.22	DO max pulse output freq.	0.1K~20.0K (max 20KHz)	0.1KHz	10.0KHz	○
P4.23	Set counts given	F4.20~9999	1	0	○
P4.24	Specified counts given	0~F4.19	1	0	○

P4.21,P4.22 are the complement to function 12,13 listed in Table 6-6.

Set counts given: It refers to when how many pulse signals input from Xi (count trigger signal input function terminal), OC (2-way open collector output terminal) or relay outputs an index signal.

When Xi inputs the 8th pulse signal, OC outputs an index signal, that is P4.21=8, shown as Fig.6-26.

Specified counts given: It refers to when how many pulse signals input from Xi, OC or relay outputs an index signal, until set counts arrival.

When Xi inputs the 5th pulse signal, relay outputs an index signal, until set counts 8 arrival, that is P4.22=5, shown as Fig.6-27. When specified counts bigger than set counts, specified counts invalid.

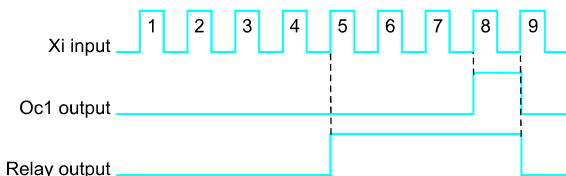

Fig.6-26 set counts given and specified counts given

Func Code	Name	Range	Min Unit	Factory Default	Modify
P4.25	Overload pre-alarm detection level	20%~200%	1	130%	○
P4.26	Overload pre-alarm delay time	0.0~20.0s	0.1s	5.0s	○

If output current exceeds continuously current detection level set by P4.23 (the actual detection level current = P4.23 X inverter rated current), after the delay time set by P4.24, the open collector outputs valid signal shown as Fig. 6-27 (refer to P4.11).

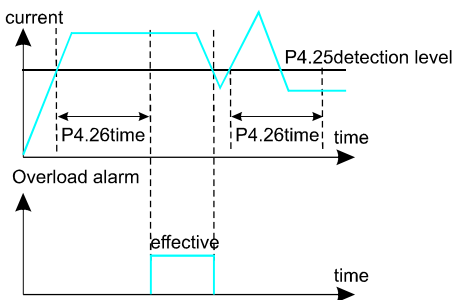

Fig.6-27 overload alarm

6.6 Protection Function Parameter (P5 Group)

Func Code	Name	Range	Min Unit	Factory Default	Modify
P5.00	Motor overload protection mode selection	0~1	1	0	×

This parameter defines the inverter protection mode in the case of overload, over current.

0: Stop outputting: In the case of overload, over current, the inverter will stop outputting at once, and the motor will go to free stopping

1: Inaction: Without overload protection to load motor , please use this function in caution.

Func Code	Name	Range	Min Unit	Factory Default	Modify
P5.01	Motor overload protection coefficient	20~120%	1	100%	×

This parameter is used for setting sensitivity of thermal relay protection to load motor. When motor output current doesn't match inverter rated current, by setting this parameter it could get correct protection to motor, shown as Fig.6-28.

$$[P5.01] = \frac{\text{Motor rated current}}{\text{Inverter rated output current}} * 100\%$$

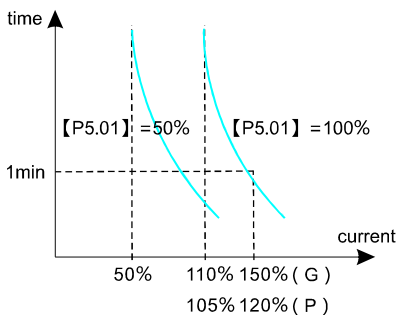

Fig. 6-30 Thermal relay protection

Note:

✦ Note: When one inverter drives multi-motor in linkage running, the thermal relay protection will be out of action. Please install thermal relay to each motor input terminal as to protect the motor effectively.

Func Code	Name	Range	Min Unit	Factory Default	Modify
P5.02	Overvoltage stall Selection	0~1	1	1	×
P5.03	Overvoltage stall point	380V : 120~150% 220V : 110~130%	1%	140% 120%	○

0 : prohibited

1 : allowed

In inverter Dec running process, because of the affection of load inertia, the actual Dec rate of motor speed may be lower than output frequency Dec rate. At this moment the motor will feed back electrical energy to inverter which will cause the bus bar voltage rising. If don't take measures, the overvoltage protection will be triggered. In the inverter Dec running process, the overvoltage stall protection function will detect the bus bar voltage and compare it with overvoltage stall point defined by P5.03 (relative to standard bus bar voltage), if it exceeds overvoltage stall point, the inverter will stop decreasing output frequency. After detecting bus bar voltage lower than overvoltage stall point again, the Dec process will restart, shown as Fig.6-29.

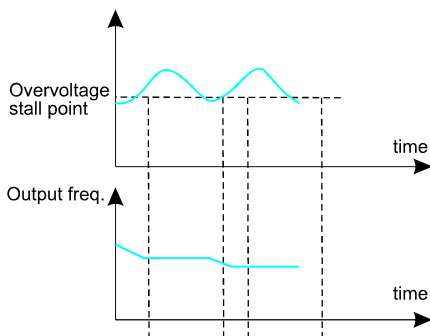

Fig.6-29 overvoltage stall

Func Code	Name	Range	Min Unit	Factory Default	Modify
P5.04	Auto current limit level	110%~200%	1%	150%	×
P5.05	Freq. drop rate during current limit	0.00~99.99Hz/s	0.01Hz/s	10.00Hz/s	○
P5.06	Auto current limit mode selection	0~1	1	1	×

Auto current limit function is to auto limit the load current not to exceed auto current limit level (P5.04) by real time monitoring the load current in order to prevent fault trip caused by over current. It is suitable to some applications with bigger inertia or load change in intensity.

Function code P5.04 defines the current threshold value of auto current limit action; the set range is a percentage to inverter rated current. Function code P5.05 defines regulating rate to output frequency during auto current limit action.

If freq. drop rate (P5.05) during current limit is too small to get rid of auto current limit state, it may finally cause load fault. If freq. drop rate is too big to intensify frequency regulating range, it may cause inverter overvoltage protection.

Auto current limit function is always valid during Acc/Dec state. Auto current limit mode selection (P5.06) defines whether auto current limit function is valid in constant speed running state.

P5.06=0 Auto current limit invalid in constant speed running;

P5.06=1 Auto current limit valid in constant speed running;

Auto current limit function is not suitable to constant speed running requiring stable output frequency, because the output frequency may changes during auto current limit action.

Func Code	Name	Range	Min Unit	Factory Default	Modify
P5.07	Restart setting after power failure	0~1	1	0	×
P5.08	Restart waiting time after power failure	0.0~10.0s	0.1s	0.5s	×

P5.07 = 0 · Restart after momentary power failure inaction;

P5.07 = 1 · Restart after momentary power failure inaction;

If occur momentary power failure (LED displays 'E-11') in inverter running state, when power comes back, the inverter will automatically execute tracking speed restart mode after waiting for time set by P5.08. During the waiting time, even there is a run command inputting, the inverter will not restart. If stopping command is input at that time, the inverter will cancel tracking speed restart.

Func Code	Name	Range	Min Unit	Factory Default	Modify
P5.09	Restart setting after power failure	0~10	1	0	×
P5.10	Self-recovery interval time	0.5~20.0s	0.1s	5.0s	×

During inverter running, fault may occur accidentally and inverter output may stop due to load fluctuation. At the moment, user may use fault self-recovery function in order not to stop running of equipment driven by inverter. In the process of self-recovery, the inverter will execute tracking speed restart mode. If the inverter fails to restart successfully in set times defined by P5.10, it will execute fault protection and stop output.

Note:

- ✦ This function is used on condition that the inverter has no substantial fault and self-recovery function is allowed by equipment;
- ✦ This function is invalid to fault protection due to overload or overheat.

Func Code	Name	Range	Min Unit	Factory Default	Modify
P5.11	Input missing phase protection	0~1	1	0	○

0: Inaction

1: Action

Note:

- ✦ U phase missing protection, displays E-26;
- ✦ V phase missing protection, displays E-27;
- ✦ W phase missing protection, displays E-28.

6.7 Fault Record Function Parameter (P6 Group)

Func Code	Name	Range	Min Unit	Factory Default	Modify
P6.00	Previous failure record	Previous failure record	1	0	*
P6.07	Previous secondary fault record	Previous secondary fault record	1	0	*
P6.08	Previous third failure records	Previous third failure records	1	0	*
P6.09	Previous fourth failure record	Previous fourth failure record	1	0	*
P6.10	Previous fifth failure record	Previous fifth failure record	1	0	*
P6.11	Previous sixth failure record	Previous sixth failure record	1	0	*

0: No fault

1~17 : E-01~E-17 fault, refer to Chapter 7.

Func Code	Name	Range	Min Unit	Factory Default	Modify
P6.01	Output frequency at the previous fault	Output frequency at the previous fault	0.01Hz	0	*
P6.02	Set frequency at the previous fault	Set frequency at the previous fault	0.01Hz	0	*
P6.03	Output current at the previous fault	Output current at the previous fault	0.1A	0	*
P6.04	Output voltage at the previous fault	Output voltage at the previous fault	1V	0	*
P6.05	DC bus voltage at the previous fault	DC bus voltage at the previous fault	1V	0	*
P6.06	Module temperature at the previous fault	Module temperature at the previous fault	10C	0	*

6.8 Close Loop Running Control Function parameter (P7 Group)

Analog feedback control system:

Input pressure given value by VI and input 4~20mA feedback value of pressure sensor by CI, constitute an analog feedback control system through built-in PI adjuster shown as Fig.6-30.

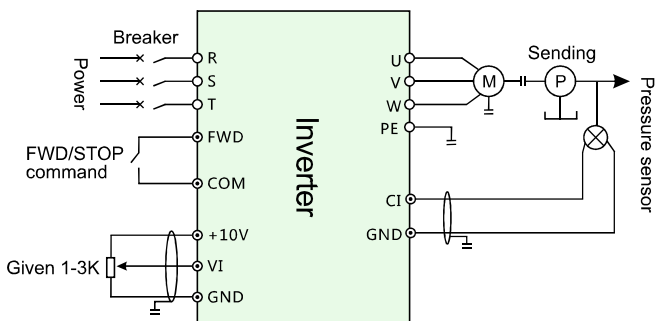

Figure 6-30 Built-in PI simulation feedback control system diagram

Func Code	Name	Range	Min Unit	Factory Default	Modify
P7.00	Close loop running control selection	0~1	1	0	×

0 : Invalid

1 : Valid

Func Code	Name	Range	Min Unit	Factory Default	Modify
P7.01	Close loop given channel selection	0~2	1	0	×

0: Digital given

1: VI analog 0~10V voltage given ◦

2: CI analog 0~10V voltage given or 4~20mA current given. To speed close loop, analog given 10V corresponding the rotate speed of max output frequency.

Func Code	Name	Range	Min Unit	Factory Default	Modify
P7.02	Feedback channel selection	0~6	1	0	×

0: VI analog 0~10V input voltage

1: CI analog 0~10V input voltage

2 : VI +CI

3 : VI - CI

4 : Min { VI · CI }

5 : Max { VI · CI }

6 : CI analog 4 – 20mA input voltage. System board JP3 jumper to jump to the " I " side, so as to select 4 ~ 20mA current feedback input.

Func Code	Name	Range	Min Unit	Factory Default	Modify
P7.03	Given channel filtering time constant	0.01~50.00s	0.01s	0.50s	○
P7.04	Feedback channel filtering time constant	0.01~50.00s	0.01s	0.50s	○

External to a given and feedback channels are often superimposed on the interference, by setting the P7.03 and P7.04 filter time constant on the channel filter, filter the longer the anti-interference ability is stronger, but the response is slow. Filter time shorter response more quickly, but the anti-interference ability is weak.

Func Code	Name	Range	Min Unit	Factory Default	Modify
P7.05	Given value digital setting	0.001~20.000Mpa	0.001 Mpa	0.000Mpa	×

As P7.01=0, P7.05 defined value is used as close loop control system given value, that user can change system given value by revising P7.05 when using control panel or serial port to control close loop system.

Func Code	Name	Range	Min Unit	Factory Default	Modify
P7.06	Close loop adjustment characteristics	0~1	1	0	○

The parameters used to define the feedback signal and the preset relationship between signal:

0 : Positive characteristic: Said feedback signal corresponding to maximum capacity maximum.

1 : Negative characteristic: Said feedback signal corresponding to maximum quantity minimum.

Func Code	Name	Range	Min Unit	Factory Default	Modify
P7.07	Feedback channel gain	0.01~10.00	0.01	1.00	×

As the feedback channel and the channel signal level is not consistent, with the parameters of the feedback channel signal gain adjustment.

Func Code	Name	Range	Min Unit	Factory Default	Modify
P7.08	Lower pressure limit	0.01~10.00	0.001	0.001	○
P7.09	Upper pressure limit	P7.08~P7.27	0.001	1.000	○

This parameter is used to set upper and lower limit pressure, when the set pressure is greater than the P7.09 value, the maximum set pressure value for P7.09, when the set pressure is less than the value of P7.08, set the minimum pressure for the P7.08 value.

Func Code	Name	Range	Min Unit	Factory Default	Modify
P7.10	PID Controller structure	0.01~10.00	1	1	×

This parameter is used to select the built-in PID controller structure.

0 : Proportional control ;

1 : Integral control;

2 : Proportion, integral control ;

3 : Proportion, integral, differential control.

Func Code	Name	Range	Min Unit	Factory Default	Modify
P7.11	Proportional gain KP	0.00~5.00	0.01	0.50	○
P7.12	Integral time constant	0.1~100.0s	0.1	10.0s	○
P7.13	Differential gain	0.0~5.0	0.1	10.0s	×

Built-in PID controller parameters setting, should according to the actual demand and system adjustment.

Func Code	Name	Range	Min Unit	Factory Default	Modify
P7.14	Sampling period	0.01~1.00s	0.01	0.10	○

Feedback value sampling period.

Func Code	Name	Range	Min Unit	Factory Default	Modify
P7.15	Tolerance limit	0.0~20.0%	0.1%	0.0%	○

Loop setting point maximum allowable deviation, as shown in figure 6-37. When the amount of feedback keeps in this range, the PI regulator will stop adjustment. This function is reasonable use contribute to the coordination of system output precision and stability of the contradiction between.

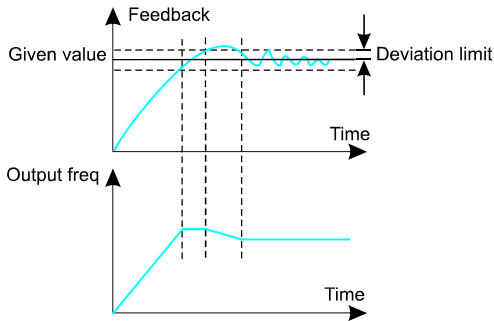

Fig.6-31 Deviation limit

Func Code	Name	Range	Min Unit	Factory Default	Modify
P7.16	PID Feedback disconnected detection threshold	0~Upper limit freq	0.01Hz	0.00Hz	○
P7.17	PID Feedback disconnected action selection	0~3	1	0	○
P7.18	PID Feedback disconnected operation delay time	0.01~5.00s	0.01s	1.00s	○

As the PID feedback value below P7.16 set detection threshold, the accumulated delay time P7.18 seconds later, it is judged to feedback disconnected. The action will be defined by the parameter P7.17 selection after feedback offline.

0 : Stop;

1 : According to the P0.02 setting frequency operation;

2 : According to upper limit frequency operation;

3 : According to upper limit frequency half running.

Func Code	Name	Range	Min Unit	Factory Default	Modify
P7.19	Pressure level	0.001~P7.20	0.001 Mpa	0.001Mpa	○

This parameter defines the system from a hibernation state to enter the working state of the pressure limit.

As the pipeline pressure is smaller than the set value, illustrate the tap water pressure to reduce or increase in the water content, frequency conversion water supply system automatically from the dormant state to state.

Func Code	Name	Range	Min Unit	Factory Default	Modify
P7.20	Hibernation pressure level	P7.19~P7.27	01	00	○

This parameter defines the system enters a hibernation state stress limit value.

As the pipeline pressure is greater than the set value, and the frequency of water supply systems have been adjusted to the hibernation frequency operation, descriptions of actual water decrease sharply or tap water pressure increases, the frequency of water supply system to automatically enter a state of dormancy, stop wait wake.

As the water supply system to reach the awake and hibernation condition, enter the awakening and hibernation latency by the parameter P7.21 and P7.23 to determine.

Func Code	Name	Range	Min Unit	Factory Default	Modify
P7.21	Hibernation level continuous time	0~250s	1s	10s	○

The parameter setting in hibernation, pipe network pressure in hibernation pressure level maintained in continuous time.

Func Code	Name	Range	Min Unit	Factory Default	Modify
P7.22	Hibernation frequency	0.00~400.0Hz	0.01Hz	20.00Hz	○

The parameter is setting the minimum operating enter into hibernation state.

Func Code	Name	Range	Min Unit	Factory Default	Modify
P7.23	Hibernation frequency continuous time	0~250s	1s	10s	○

The parameter is setting inverter running time, when reach the hibernation frequency.

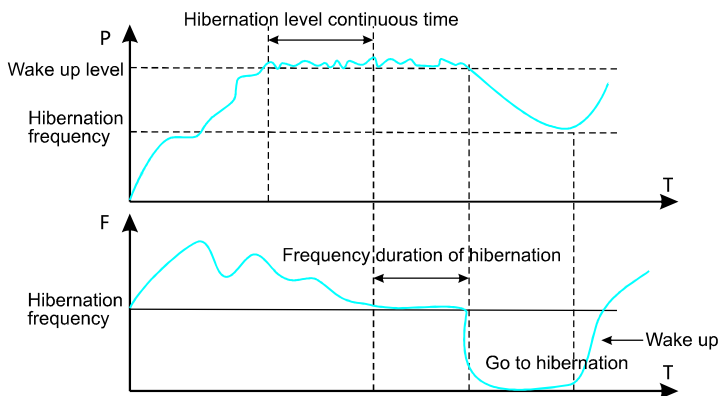

Fig.6-32 Hibernation wake diagram

Func Code	Name	Range	Min Unit	Factory Default	Modify
P7.24	Low alarm limit pressure	0.001~P7.25	0.001 Mpa	0.001M pa	○
P7.25	The alarm limit pressure	P7.24~P7.27	0.001 Mpa	0.001M pa	○

As the pressure of a pipe network under lower pressure, and the inverter frequency reaches the set upper limit frequency of or all the pump frequency operation, indicates that the pipeline under pressure, frequency converter can output alarm signal. P4.10 or P4.11 is set to 21, then the maximum pressure alarm.

As the pipeline pressure is greater than the upper limit of pressure, and the inverter frequency reaches the set lower limit of frequency, indicates that the pipeline pressure, frequency converter can output alarm signal. This function can be used to determine the pipeline blocking. P4.10 or P4.11 is set to 22, is the output of lower pressure alarm.

Func Code	Name	Range	Min Unit	Factory Default	Modify
P7.26	Constant pressure water supply mode	0~4	1	0	×

0 : No constant pressure water supply mode.

1 : One pump water supply mode (Selection of the constant pressure water supply board) .

2 : Two pumps water supply mode (Selection of the constant pressure water supply board) .

3 : Three pumps water supply mode (Selection of the constant pressure water supply board) .

4 : Four pumps water supply mode (Selection of the constant pressure water supply board) .

Func Code	Name	Range	Min Unit	Factory Default	Modify
P7.27	Remote pressure gauge range	0.001~20.000Mpa	0.001 Mpa	1.000M pa	○

This parameter setting is equal to actual use of gauge range, corresponding to 10V or 20mA.

Func Code	Name	Range	Min Unit	Factory Default	Modify
P7.28	Multi pump operation mode	0~1	1	0	○
P7.29	Rotation in timed intervals	0.5~100.0H	0.1H	5.0H	○

Multi pump operation mode for each pump capacity the same system ◦

0 : Fixed sequence shift: According to the detected pressure changes at a fixed shifting sequence plus or minus pump. General pump start from 0;

1 : Timing of the Shift: This way is actually at a certain time after redefine each pump number, to ensure that each pump can get equal chance and time to run, in order to prevent the pump break for a long time no using. Timing of operation time by P7.29 parameter defined.

Func Code	Name	Range	Min Unit	Factory Default	Modify
P7.30	Pump switching judgment time	0.1~1000.0s	0.1s	300.0s	○

This parameter is used to set the judgment of stability time, when increase or deduce the pump Nos. The setting of parameters too short will cause the system pressure shocks, but the pressure response more quickly.

Func Code	Name	Range	Min Unit	Factory Default	Modify
P7.31	Electromagnetic switching delay time	0.1~10.0s	0.1s	0.5s	×

The parameters used to define system delay time of electromagnetic switch, when the switching from Grid frequency to Variable frequency or Variable frequency to Grid frequency.. In order to prevent the circuit shorten between the inverter output terminal and power supply caused by electromagnetic switch delay.

Func Code	Name	Range	Min Unit	Factory Default	Modify
P7.32	PID Control of positive and negative role and feedback pressure error polarity	00~11	1	00	×
P7.33	Feedback error of pressure adjustment coefficient	0.001~20.000Mpa	0.001 Mpa	0.000Mpa	×

PID Control of positive and negative role and feedback pressure error polarity	
Unit :	0: PID forward action 1: PID reverse action
Ten :	0: The feedback pressure is greater than the actual pressure 1: feedback pressure is less than actual pressure
Hundred :	0: wake up sleep pressure is actual pressure 1: wake up sleep pressure is set pressure
Thousand :	0: Press to view the monitoring parameters, and the B group monitoring parameters are viewed in order 1: Press to view the monitoring parameters. The monitoring parameters of group B only view the three parameters of set pressure, output current and output frequency

As the PID is stable, found the set pressure and actual pipeline pressure deviation, can be adjusted by P7.32 and P7.33 to eliminate the error, when the actual pipeline pressure is greater than set pressure, P7.3 ten bit set to " 1 ", and the P7.33= actual pressure setting pressure, when the actual pipeline pressure is greater than set pressure, P7.33 ten bit set to " 0 ", and the P7.33=set pressure - the actual pressure.

Func Code	Name	Range	Min Unit	Factory Default	Modify
P7.34	Closed loop of preset frequency	0~Upper limit freq	0.00Hz	0.00Hz	×
P7.35	Closed loop of preset frequency holding time	0.0~200.0s	0.1s	0.0s	×

The function code can make the closed-loop regulation quickly into the stable stage.

Inverter will accelerate to closed loop of preset point P7.34 and running at the frequency for a period of time. After that time, inverter will run as closed loop operation.

6.9 PLC Running Parameter (P8 Group)

Simple PLC function is a multi-stage speed generator. The inverter can auto change frequency and running direction in set running time to satisfy the techniques command shown as Fig.6-33.

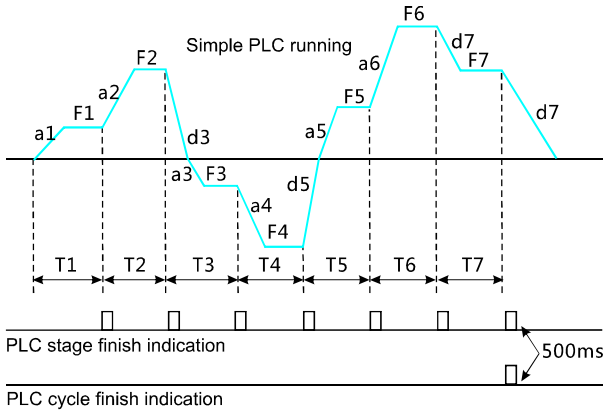

Fig.6-33 simple PLC running

a1~a7, d1~d7 are Acc and Dec time in each stage shown as Fig.6-39, which are defined by Acc/Dec time parameter P0.17,P0.18 and P3.14~P3.25.

F1~F7, T1~T7 are running frequency and running time which are defined by function code P8.01~P8.14.

Func Code	Name	Range	Min Unit	Factory Default	Modify
P8.00	PLC running mode selection	LED unit: 0~3; ten: 0,1; hundred: 0,1; thousand:0,1	1	0000	×

LED unit's digit: PLC running mode selection

0: naction

1: Stop after single cycle

The inverter will stop automatically after one cycle. It will restart after receiving a new running command shown as Fig.6-34.

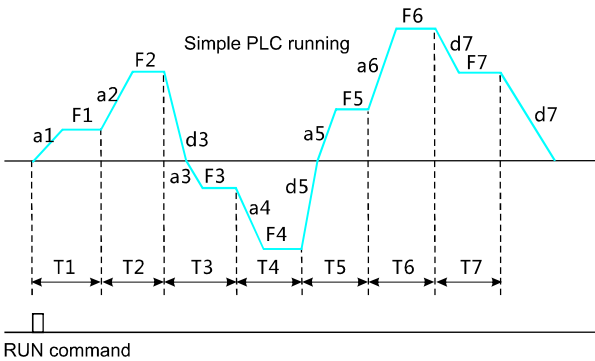

Fig.6-34 PLC stop after single cycle

2 : Running at final frequency after single cycle:

The inverter will keep running at the frequency and direction of final stage after one cycle. It will stop in set dec time after receiving stopping command shown as Fig.6-35.

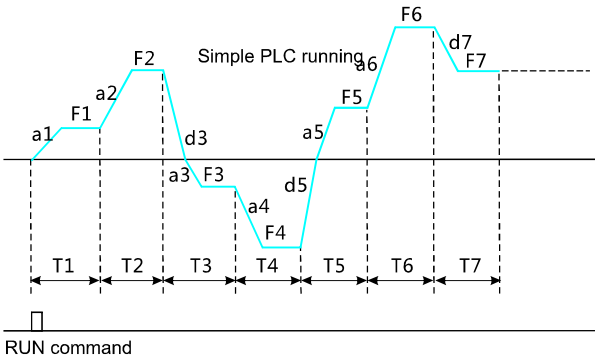

Fig.6-35 PLC running at final frequency after single cycle

3 : Continuous cycle

The inverter automatically starts a new cycle after one cycle finish until receiving stopping command shown as Fig.6-36.

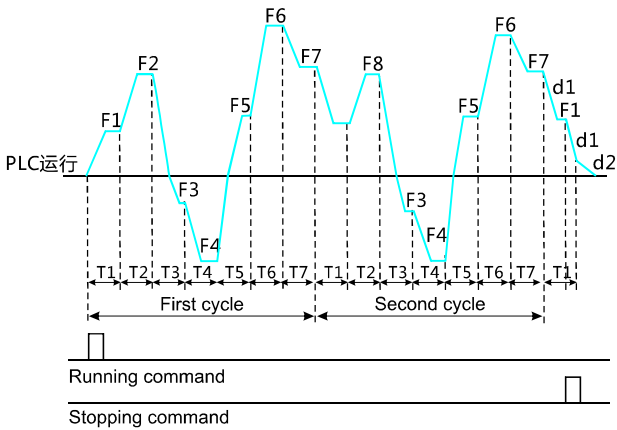

Fig.6-36 PLC continuous cycle

LED ten's digit: PLC restart mode selection

0 : Restart from the first stage after stop caused by stopping command, fault or power failure.

1: Restart from the freq. of break stage. After stop caused by stopping command or fault, the inverter will record the running time completed of starts from break stage and runs at set freq. of break stage in rest time of break stage shown as Fig.6-37.

Chapter 6

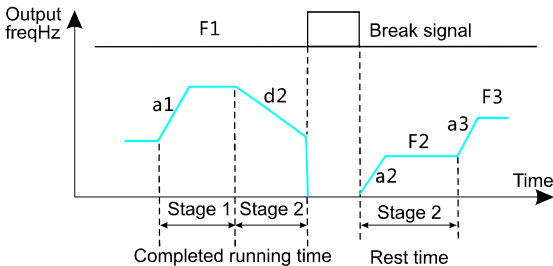

a1: Acc time of stage 1 a2: Acc time of stage 2 a3: Acc time of stage 3
 d2: Dec time of stage 2 F1: freq of stage 1 F2: freq of stage 2 F3: freq of stage 3

Fig.6-37 PLC restart mode 1

LED hundred's digit: PLC state parameter save mode selection

0: No save. Inverter don't save PLC running state after power failure and restart from the first stage.

1: Save. Inverter saves PLC running state after power failure, including running frequency and running time of break stage.

LED thousand's digit: PLC running time unit

0: Second

1: Minute

The unit only run on PLC stage time definition Validly, PLC operation during deceleration time unit selection is determined by P0.16.

Note:

- ✦ PLC for a certain period of time setting 0, means the stage is invalid.
- ✦ Through the terminal, PLC process can be suspended, failure, operation control, refer to group P4 terminal related functional parameter group.

Func Code	Name	Range	Min Unit	Factory Default	Modify
P8.01	Stage 1 setting	000~621	1	000	○
P8.02	Stage 1 running time	0.1~6000.0	0.1	10.0	○
P8.03	Stage 2 setting	000~621	1	000	○
P8.04	Stage 2 running time	0.1~6000.0	0.1	10.0	○
P8.05	Stage 3 setting	000~621	1	000	○
P8.06	Stage 3 running time	0.1~6000.0	0.1	10.0	○
P8.07	Stage 4 setting	000~621	1	000	○
P8.08	Stage 4 running time	0.1~6000.0	0.1	10.0	○
P8.09	Stage 5 setting	000~621	1	000	○
P8.10	Stage 5 running time	0.1~6000.0	0.1	10.0	○
P8.11	Stage 6 setting	000~621	1	000	○
P8.12	Stage 6 running time	0.1~6000.0	0.1	10.0	○
P8.13	Stage 7 setting	000~621	1	000	○
P8.14	Stage 7 running time	0.1~6000.0	0.1	10.0	○

Function code P8.01~P8.14 are used to define PLC running frequency, direction, and Acc/Dec time by LED unit's, ten's, hundred's digit as follow.

LED unit' s digit: start mode
0: Multi-stage frequency i (i=1~7) defined by P3.26-P3.32 1: Freq. defined by P0.01 function code
LED ten' s digit: running direction selection
0: Forward 1: Reverse
LED hundred' s digit: Acc/Dec time selection
0: Acc/Dec time 1 1: Acc/Dec time 2 2: Acc/Dec time 3 3: Acc/Dec time 4 4: Acc/Dec time 5 5: Acc/Dec time 6

6.10 Swing Frequency Function Parameter (P9 Group)

Swing frequency running is used in textile, chemical fiber industry, etc., and in application which needs traverse drive and winding. The typical application is shown as Fig.6-45.

The swing frequency process is normally as follow:

Firstly it accelerates to preset swing freq (P9.02) in set Acc time and waiting for a while(P9.03), then after goes to swing centre frequency in set Acc/Dec time , finally it enters into swing freq cycle running in set swing amplitude(P9.04),Kick freq (P9.05), swing freq cycle (P9.06) and delta wave ascent time (P9.07) until receiving stop command to stop in set Dec time.

The swing centre frequency comes from set frequency of normal running, multistage speed running or PLC running.

The swing freq running will be invalid automatically as JOG running or close loop running mode starts.

When PLC running with swing freq, swing frequency will be invalid during switching of PLC stage. It will go to PLC set frequency according to PLC Acc/Dec setting, then swing frequency restarts. When stopping command is received, it will decelerate to stop in PLC Dec time.

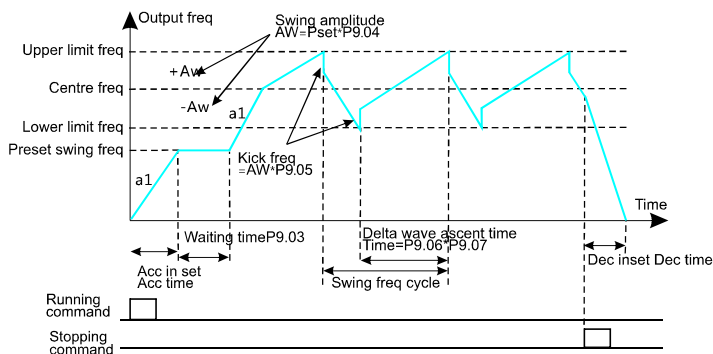

Fig.6-38 Swing frequency running

Func Code	Name	Range	Min Unit	Factory Default	Modify
P9.00	Swing freq. selection	0~1	1	0	×

0 : Inaction

1 : Action

Func Code	Name	Range	Min Unit	Factory Default	Modify
P9.00	Swing freq. running mode	0~1	1	0	×

After inspecting cable connection and power source for sure, switch on inverter input AC power switch. The inverter's LED on control panel will display dynamic start menu. When it displays set frequency, it means initialization has been completed :

Func Code	Name	Range	Min Unit	Factory Default	Modify
P9.01	Swing freq. running mode	0000~1111	1111	0000	×

LED unit' s digit: start mode

0: Auto start. It keeps running at preset swing frequency(P9.02) for a while(P9.03) after start, then after automatically enters into swing frequency running state.

1: Manual start by terminal. When multifunctional terminal is valid (Xi),it enters into swing frequency running state. When terminal is invalid, it quits from swing

LED ten' s digit: swing amplitude control

0: Variable swing amplitude. Swing amplitude AW changes according to centre freq, refer to P9.04.

1: Fixed swing amplitude. Swing amplitude AW is defined by max frequency and

Func Code	Name	Range	Min Unit	Factory Default	Modify
P9.02	Preset swing freq.	0.00~500.00Hz	0.01Hz 0.1s	0.00Hz	○
P9.03	Preset swing freq. waiting time	0.0~3600.0s	0.1s	0.0s	○

P9.02 is used for defining the running freq before swing freq running state. When auto start mode is selected, P9.03 is used for defining the duration of running at preset swing frequency. When manual start mode is selected, P9.03 is invalid. Refer to Fig.6-38.

Func Code	Name	Range	Min Unit	Factory Default	Modify
P9.04	Swing amplitude	0.0~50.0%	0.1%	0.0%	○

Variable swing amplitude:

$AW = \text{centre freq} \times P9.04$ Fixed swing amplitude:

$AW = \text{max running freq P0.06} \times P9.04$.

Note:

✦ Swing freq is restricted by upper/lower limit frequency.

Func Code	Name	Range	Min Unit	Factory Default	Modify
P9.05	Kick freq.	0.0~50.0%	0.1%	0.0%	○

P9.05=0, there is no kick freq.

Func Code	Name	Range	Min Unit	Factory Default	Modify
P9.06	Swing freq. cycle	0.1~999.9s	0.1s	10.0s	○

This function code is to define the time of a completed cycle of swing freq running.

Func Code	Name	Range	Min Unit	Factory Default	Modify
P9.07	delta wave ascent time	0.0~98.0%	0.1%	50.0%	○

Swing freq ascent stage running time=P9.06 P9.07 (second), Descent stage running time=P9.06 (1 P9.07) (second).

Note:

- + User can select S curve Acc/Dec mode at the same time when swing frequency running is selected. It can make swing freq running smooth.

Func Code	Name	Range	Min Unit	Factory Default	Modify
P9.08	Terminal UP/DOWN and Fan control selection	000~111	1	0	○

Unite digit

0: Inverter fan operation, shutdown after 1 minutes after the fan stops running ;

Ten digit

0: When Frequency is set by Terminal UP/DOWN (P0 .01=3), inverter will save the frequency value after power off. When inverter restarts, the initial frequency will be the last saving frequency;

1: When Frequency is set by Terminal UP/DOWN (P0 .01=3), inverter will not save

Hundred digit

0: Inverter run/ stop is set by Terminal (P0.03=1). After power cut off and switch on, inverter will run or stop according to Terminal setting.

1: Inverter run/ stop is set by Terminal (P0.03=1). After power cut off and switch on,

Func Code	Name	Range	Min Unit	Factory Default	Modify
P9.09	Muti-function terminal filtering time	0~4	1	1	○

The parameter is used for multi-function terminals (X1-X8) signal filtering. Increasing the value, the effect of filtering will be improved, but the Terminal response time will be longer. Reducing the value, the effect of filtering will get worse and Terminal response time is short. In some motion control application which requires instant action, parameter P9.09 should set 0.

Func Code	Name	Range	Min Unit	Factory Default	Modify
P9.10	Braking unit use rate	0~100.0%	0.1%	30.0%	○

This parameter is used to set the energy consumption braking unit switching value. When the bus voltage in excess of P9.11 (energy consumption braking bus bar voltage), braking unit will start the brake unit according to the percentage of P9.10. The high percentage setting, the braking effect is obvious and the braking current will be high. Users have to set the appropriate adjustment of P9.10 parameters and select the braking resistor.

Func Code	Name	Range	Min Unit	Factory Default	Modify
P9.11	Overpressure threshold value	0~780V	1V	780V	○
P9.12	Energy consumption braking bus bar voltage	0~780V	1V	640V Or 358V	○

This parameter is used to set the energy consumption braking start bus voltage. Three-phase 380V inverter power brake boot bus voltage is 660V, single-phase 220V inverter power brake boot bus voltage is 358V.

Func Code	Name	Range	Min Unit	Factory Default	Modify
P9.13	G/P type setting and single-phase motor type selection	0000~1111	0000	0000	○

Unit's digit:

0: G type ; 1:P type ;

Ten's digit: reserved;

Hundred's digit: reserved;

Thousand's digit: Single-phase motor type;

0: ordinary three-phase asynchronous motor(220V);

1: single-phase asynchronous motor (removing capacitor);

2: Single-phase asynchronous motor (without removing the capacitor).

Func Code	Name	Range	Min Unit	Factory Default	Modify
P9.14	User password	1~9999	1	0	○

This function is used for prohibiting non-authorized personnel to view and amend the function parameter. When P9.14=0000, this function is invalid.

When this function is needed, please enter 4 digits as password, then after press ENTER/DATA key to confirm it, the password will be Valid immediately.

Amend password: press MENU/ESC key to enter into password verification state. After original 4 digits password is entered correctly, it goes to parameter edit state. Select function code P9.14 (P9.14=0000 now), enter a new password, and press ENTER/DATA key to confirm it, the new password will be Valid immediately. The super user password is 2644.

6.11 Vector Control Parameter (PA Group)

Func Code	Name	Range	Min Unit	Factory Default	Modify
PA.00	Motor parameter Auto tuning function	0~1	1	0	×

0 : Inaction

1 : Static auto-tuning

When settings PA.00=1, inverter show "FUN0 ", then press " FWD " key to start inverter parameter auto-tuning. When keyboard display " FUN1 ", auto tuning is complete.

Func Code	Name	Range	Min Unit	Factory Default	Modify
PA.01	Motor rated voltage	0~400V	1	depends on model type	×
PA.02	Motor rated current	0.01~500.00A	0.01A	depends on model type	×
PA.03	Motor rated frequency	1~500Hz	1Hz	depends on model type	×
PA.04	Motor rated rotating speed	1~9999 r/min	1r/min	depends on model type	×
PA.05	Motor poles number	2~16	1	depends on model type	×
PA.06	Motor stator inductance	0.1~5000.0mH	0.1mH	depends on model type	×
PA.07	Motor rotor inductance	0.1~5000.0mH	0.1mH	depends on model type	×
PA.08	Motor stator and rotor mutual inductance	0.1~5000.0mH	0.1mH	depends on model type	×
PA.09	Motor stator resistance	0.001~50.000Ω	0.001Ω	depends on model type	×
PA.10	Motor rotor resistance	0.001~50.000Ω	0.001Ω	depends on model type	×

PA.01~PA.10 are defined as motor parameter. The inverter has its own factory default set parameter which depends on model type. User is able to reset above parameter according to parameter of motor used. These parameter should be entered correctly, otherwise, the vector control function can't achieve desired control effect.

Func Code	Name	Range	Min Unit	Factory Default	Modify
PA.11	Over current protection coefficient of torque current	0~15	1	15	×

In vector control mode, this function is used for controlling torque current as to prevent over current. The range of 0-15 correspond to 50%-200%.

Func Code	Name	Range	Min Unit	Factory Default	Modify
PA.12	Proportion adjustment coefficient of speed deviation	50~120	1	85	×
PA.13	Integral adjustment coefficient F speed deviation	100~500	1	360	×

In vector control mode, PA.12~PA.13 are used for controlling motor rotating speed. It can achieve better motor speed control effect by proper adjustment of these two function parameter.

Func Code	Name	Range	Min Unit	Factory Default	Modify
PA.14	Vector torque boost	100~150	1	100	×

In vector control mode, this function is used to boost output torque of motor.

It can properly increase this parameter in application with heavy load as to boost output torque of motor.

6.12 Factory Function parameter (PF Group)

Func Code	Name	Range	Min Unit	Factory Default	Modify
PF.00	Factory function	0000–9999	---	---	×

Factory function, user no need to amend it.

Chapter 7

Troubleshooting







7.1 Fault Alarm and Troubleshooting.....	142
7.2 Fault Record Search.....	145
7.3 Fault Reset	145

7.1 Fault Alarm and Troubleshooting

When the inverter is abnormal, protection function acts: LED displays fault code and the content, fault relay acts, the inverter stops output and the motor coasts to stop. YX3000 series inverter's fault contents and troubleshooting is shown in Table 7-1. After fault alarm occurs, fault phenomenon should be recorded in detail, the fault should be processed according to Table 7-1. When in need of technical assistance, please contact your supplier.

Fault code	Type of faults	Possible fault reasons	Troubleshooting
E-01	Acc over current	Acc time is too short	Adjust acc time
		V/F curve setup is not suitable	Adjust V/F curve
		Restart the motor in running	Setup start mode as speed tracking restart
		Torque boost setup is too big	Adjust torque boost or set as auto mode
		Inverter capacity is too low	Select inverter with proper capacity
E-02	Dec over current	Dec time is too short	Adjust Dec time
		Potential load or load inertia is too big	Add suitable braking device
		Inverter capacity is too low	Select inverter with proper capacity
E-03	Over current at constant speed running	Load mutation	Check load
		Acc or Dec time is too short	Adjust Acc or Dec time
		Input voltage abnormal	Check input power supply
		Load abnormal	check load
		Inverter capacity is too low	Select inverter with proper capacity
E-04	Acc overvoltage	Input voltage abnormal	Check input power supply
		Acc time is too short	Adjust Acc time
		Restart the motor in running	Setup start mode as speed tracking restart
E-05	Dec overvoltage	Dec time is too short	Adjust the Dec time
		Potential load or load inertia is too big	Add suitable braking device
E-06	Overvoltage at constant speed running	Input voltage abnormal	Check input power supply
		Acc or Dec time is too short	Adjust the Acc or Dec time
		Abnormal change of input voltage	Mount input reactor

Fault code	Type of faults	Possible fault reasons	Troubleshooting
E-06		Load inertia is too big	Add suitable braking device
E-07	Overvoltage of control power supply	Input voltage abnormal	Check input power supply
E-08	Inverter overheat	Air duct obstruction	Clean air duct
		Environment temperature is too high	Improve the ventilation or decrease the carrier frequency
		Fan damaged	Replace a new fan
		Inverter module abnormal	Contact supplier
E-09	Inverter overload	Acc time is too short	Adjust Acc time
		DC braking value is too high	Decrease DC braking current and increase braking time
		V/F curve setup is not suitable	Adjust V/F curve
		Restart the motor in running	Setup start mode as speed tracking restart
		Mains voltage is too low	Check mains voltage
		Too heavy load	Select inverter with proper capacity
E-10	Motor overload	V/F curve setup is not suitable	Adjust V/F curve
		Mains voltage is too low	Check mains voltage
		General motor runs at low speed with heavy load for long term	Use a special motor for long term running
		Wrong setting of motor overload protection factor	Set the factor right
		Motor chocked or sudden change of load	Check load
E-11	Under voltage in running	Mains voltage is too low	Check mains voltage
E-12	Inverter module protection	Inverter over current	Refer to over current troubleshooting
		Output 3-phase fault or ground short	Re-wiring
		Air duct obstruction or fan damaged	Clean air duct or replace a new fan

Fault code	Type of faults	Possible fault reasons	Troubleshooting
E-12	Inverter module protection	Environment temperature too high	Decrease environment temperature
		Control board connecting wire or plug-in unit loose	Check and re-wiring
		Current waveform abnormal due to output missing phase, etc.	Check wiring
		Auxiliary power damaged, or driving voltage under voltage	Contact supplier
		Control board abnormality	Contact supplier
E-13	Peripheral fault	Close external fault terminals	Check the reason
E-14	Current detecting circuit fault	Loose wiring or terminal connections	Check and re-wiring
		Auxiliary power source damaged	Contact supplier
		Hall component damaged	Contact supplier
		Abnormal amplifier circuit	Contact supplier
E-15	RS232/485 Communication fault	Wrong baud rate setting	Set baud rate properly
		Serial port communication fault	Press  Key to reset or contact supplier
		Improper fault alarm parameter setting	Revise function code P3.09~P3.12
		Upper computer doesn't work	Check upper computer and connecting cable
E-16	System interference	Serious interference	Press  key to reset or install input power source filter
		DSP read/write error	Reset or contact supplier
E-17	EP ² PPROM error	Read/write error of control parameter	press  key to reset or install input power source filter
E-18	Motor parameter over current fault	Power range of Motor and inverter do not match	Contact supplier press  key to reset
E-19	Input phase loss protection	One of R, S, T port has no voltage	Press  key to reset check voltage of R, S, T
E-20	over current fault when restart	Over current when inverter restart and check speed	press  key to reset adjust relevant parameters

7.2 Fault Record Search

This series inverter record the fault codes occurred in the last 6times and inverter running parameter when last fault occurred. The fault information is saved in P6 group.

7.3 Fault Reset

- When fault occurred, please select the following methods to recover:
- When fault code is displayed, after ensure it can be reset, press  key to reset.
- Set any one of X1~X8 terminal as external RESET input (P4.00~P4.07=17).
- Cut off power.



ATTENTION

- Reset the inverter after thoroughly investigating the cause of fault and clearing, otherwise, the inverter may be damaged;
- If it can't be reseted or fault occurs again after reset, please check the cause of fault, continuous reset may damage inverter;
- Reset the inverter after waiting for 5min when overload or overheat protection occurs.

Chapter 8

Preservation and Maintenance

8.1 Preservation and Maintenance.....	148
8.2 Periodic Preservation and Maintenance.....	148
8.3 Warranty of Inverter.....	149

8.1 Preservation and Maintenance

Potential hazards exist due to aging, wear and tear of inverter internal components as well as environmental influences to the inverter, such as temperature, humidity particles etc.. Therefore, daily inspection, periodic preservation and maintenance must be performed to the inverter and its driving mechanism during their storage and operation.

Daily Maintenance

The following must be verified before starting up :

- No abnormal vibration and no abnormal noise;
- No abnormal heat;
- No abnormal ambient temperature;
- The ammeter satisfy the specification;
- Fan is working in good condition.

8.2 Periodic Preservation and Maintenance

8.2.1 Periodic Maintenance

Cut off the power when inverter is maintained thermally, check after the main circuit power indicator light is off. The checking content is shown in Table 8-1.

Checking item	Checking content	Troubleshooting
Screws of control terminals and main circuit terminals	The screws are loose or not	If loose, tighten them with screw driver
heat sink	Whether there is dust	Clean thoroughly the dust P
Printed circuit board	Whether there is dust	Clean thoroughly the dust
Cooling fans	Whether there is abnormal vibration or abnormal noise	Replace cooling fans
Power element	Whether there is dust	Clean thoroughly the dust
Electrolytic capacitor	Whether there is discoloring, peculiar smell	Replace electrolytic capacitor

table 8-1 Periodic inspections

8.2.2 Thermally maintaining

In order to let inverter work well for a long term, user must maintain the inverter thermally. The replace time of element of inverter is shown in Table 8-2.

Items	Time criterion
Cooling fans	2-3 years
Electrolytic capacitors	4-5 years
Printed circuit board	5-8 years
Fuse	10 years

Table 8-2 frequency inverter parts replacement

The working condition of the inverter as following:

- Environment temperature: average 30C;
- Load coefficient: under 80%;
- Running time: under 12 hour everyday.

8.3 Warranty of Inverter

Our company supply warranty in the following condition:

- ❶ Only inverter in the warranty range;
- ❷ In the normal using, inverter damaged in 15 month. Over 15 month, our company will charge for the repair service.
- ❸ In the following condition in 15 month, our company also will charge for the repair service:
 - A. Inverter is damaged caused by user not complying with instructions.
 - B. Inverter is damaged caused by fire, flood, and abnormal voltage.
 - C. Inverter is damaged caused by wrong wiring.
 - D. Inverter is damaged when it is used in the abnormal applications.
- ❹ Service charge will be calculated with reference to actual cost, but if included in the contract, then according to the contract.

Chapter 9

Serial Port Communication Protocol of Rs485

9.1 Communication Overview.....	152
9.2 Communication Protocol Specification.....	152
9.3 The ASCII Communication Protocol.....	153

9.1 Communication overview

Our series of inverters provide users with a common industrial control RS485 communication interface, in which The MODBUS standard protocol is used for communication. The inverters can be used as slave connected to the host (such as PLC controller, PC), both of which have the same communication interface and protocol, for the purpose of centralized monitoring of the inverters. Or one inverter can be used as host and other inverters as slaves, all connected with RS485 communication interface, to achieve multi-machine interaction of the inverters. And with this communication interface, a Keyboard can also be connected to inverters for remote operation.

The MODBUS communication protocol of the inverter supports two transmitting ways: RTU mode and ASCII, and either can be choose. The following is a detailed description of the communication protocol of the inverter.

9.2 Communication protocol specification

9.2.1 Communications networking methods

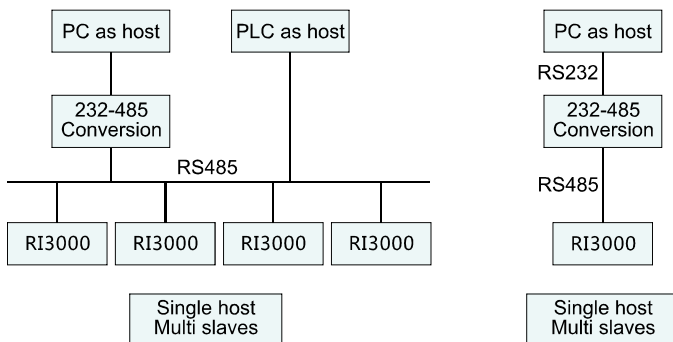

Fig.9-1 networking of slaves

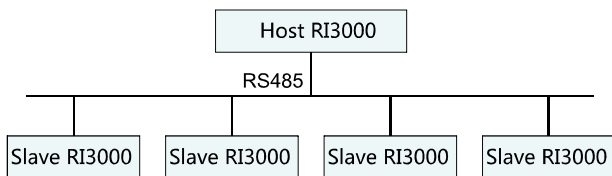

Fig9-2 The networking of multi-machine interaction

9.2.2 Communication protocol

The inverter can either be used as a host or slave in RS485 network. It can be used for controlling other inverters as host to achieve multi-level linkage, or controlled by host (PC or PLC) as a slave. The specific communication mode is as follows:

- Inverter is used as slave, in point-to-point communication of master-slave mode. Host sends commands from broadcast address, while slave doesn't answer;
- Inverter is used as host, sending commands from broadcast address, while slave doesn't answer;
- The address, baud rate and data format of the inverter can be set up by using the keyboard or the serial communication;
- message of error is reported by slave, in the recent response frame against host polling.

9.2.3 Communication Interface

The communication is using RS485 interface, with asynchronous serial and half-duplex transmission. The default communication protocol is in ASCII mode.

The default data format: 1 start bit, 7 data bits, 2 stop bits.

The default rate is 9600bps. Communication parameter settings reference P3.09 ~ P3.12 function code.

9.3 The ASCII Communication Protocol

(1-7-2 format, no parity)

Start bit	BIT 0	BIT 1	BIT 2	BIT 3	BIT 4	BIT 5	BIT 6	BIT 7	Stop bit	Stop bit
-----------	-------	-------	-------	-------	-------	-------	-------	-------	----------	----------

(1-7-1 format, odd parity)

Start bit	BIT 0	BIT 1	BIT 2	BIT 3	BIT 4	BIT 5	BIT 6	BIT 7	Parity bit	Stop bit
-----------	-------	-------	-------	-------	-------	-------	-------	-------	------------	----------

(1-7-1 format, even parity)

Start bit	BIT 0	BIT 1	BIT 2	BIT 3	BIT 4	BIT 5	BIT 6	BIT 7	Parity bit	Stop bit
-----------	-------	-------	-------	-------	-------	-------	-------	-------	------------	----------

(1-8-2 format, no parity)

Start bit	BIT 0	BIT 1	BIT 2	BIT 3	BIT 4	BIT 5	BIT 6	BIT 7	Stop bit	Stop bit
-----------	-------	-------	-------	-------	-------	-------	-------	-------	----------	----------

(1-8-1 format, odd parity)

Start bit	BIT 0	BIT 1	BIT 2	BIT 3	BIT 4	BIT 5	BIT 6	BIT 7	Parity bit	Stop bit
-----------	-------	-------	-------	-------	-------	-------	-------	-------	------------	----------

(1-8-1 format, even parity)

Start bit	BIT 0	BIT 1	BIT 2	BIT 3	BIT 4	BIT 5	BIT 6	BIT 7	Even parity	Stop bit
-----------	-------	-------	-------	-------	-------	-------	-------	-------	-------------	----------

Communications data structures

ASCII mode

Frame header	Start character= " : " (3AH)
Address Hi	Address : 8-bit address combined with two ASCII code
Address Lo	
Function Hi	Function code :
Function Lo	8-bit address combined with two ASCII code
DATA (n - 1)	Data content :
.....	n * 8-bit data content combined with 2 * n ASCII code, in which high in front and low in post, n <= 4, 8 ASCII code as
DATA 0	
LRC CHK Hi	LRC Check code :
LRC CHK Lo	8 check code combined with two ASCII code
END Hi	End character :
END	END Hi = CR(0DH), END Lo = CR(0AH)

RTU mode:

START	Maintaining no input signal for more than or equal to 10ms
Address	address : 8-bit Binary address
Function	Function code : 8-bit Binary address
DATA (n - 1)	Data content : N*8-bit data , N<=8 , less than 8 bytes
.....	
DATA 0	
CRC CHK Low	CRC Check code
CRC CHK High	16-bit CRC check code is combined with 2 8-bit Binary code
END	Maintaining no input signal for more than or equal to 10ms

Address:

00H : All broadcast from inverters

01H : Communication with inverter of 01 address

0FH : Communication with inverter of 15 address

10H : Communication with inverter of 15 address, and so on, maximum to 254 (FEH) 。

Function and DATA code:

03H : Read data from a register

06H : Write data to the register.

08H : Loop detection.

Function code 03H : Read data from a register :

For example : read data from the address 2104H of register (Output current)

ASCII mode:

Asking for information string format		Answering information string format	
Header	" : " ---3AH	Header	" : " ---3AH
Address	"0"---30H	Address	"0"---30H
	"1"---31H		"1"---31H
Function code	"0"---30H	Function code	"0"---30H
	"3"---33H		"3"---33H

Asking for information string format		Answering information string format	
content	"2"---32H	Information number	"0"---30H
	"1"---31H		"2"---32H
	"0"---30H		
	"4"---34H	Content of address 2104H	"0"---30H
	"0"---30H		
	"0"---30H		
	"0"---30H		
LRC CHECK	LRC CHECK "D" ---44H	LRC CHECK	"D" ---44H
	"7" ---37H		"7" ---37H
END	END CR ---0DH	END	CR ---0DH
	LF ---0AH		LF ---0AH

RTU mode:

Asking for information string format		Answering information string format	
Address	01H	Address	01H
Function code	03H	Function code	03H
content	21H	Information number	02H
CRC CHECK Low	04H	content	00H
	E8H	CRC CHECK Low	00H
			0EH
CRC CHECK High	4BH	CRC CHECK High	37H

Function code 06H : Write to register

For example : writing function code P0.02=50.00HZ to inverter address 01H.

ASCII mode:

Asking for information string format		Answering information string format	
Header	" : " ---3AH	Header	" : " ---3AH
Address	"0"---30H	Address	"0"---30H
	"1"---31H		"1"---31H

Asking for information string format		Answering information string format	
Function code	"0"---30H	Function code	"0"---30H
	"6"---36H		"6"---36H
content	"0"---30H	content	"0"---30H
	"0"---30H		"0"---30H
	"0"---30H		"0"---30H
	"2"---32H		"2"---32H
	"1"---31H	Data of address 2104H	"1"---31H
	"3"---33H		"3"---33H
	"8"---38H		"8"---38H
LRC CHECK	"5" ---35H	LRC CHECK	"5" ---35H
	"C" ---43H		"C" ---43H
END	CR ---0DH	END	CR ---0DH
	LF ---0AH		LF ---0AH

RTU mode:

Asking for information string format		Answering information string format	
Address	00H	Address	01H
Function code	06H	Function code	06H
content	00H	content	00H
	02H		02H
	13H		13H
	88H		88H
CRC CHECK Low	25H	CRC CHECK Low	25H
CRC CHECK High	5CH	CRC CHECK High	5CH

Function code : 08H Communication loop test

This command is used to test the communication between main control equipment and inverter. Inverter receives and sends back the message to the main control equipment.

ASCII mode:

Asking for information string format		Answering information string format	
Header	" : " ---3AH	Header	" : " ---3AH
Address	"0"---30H	Address	"0"---30H
	"1"---31H		"1"---31H
Function code	"0"---30H	Function code	"0"---30H
	"8"---38H		"8"---38H
content	"0"---30H	content	"0"---30H
	"1"---31H		"1"---31H
	"0"---30H		"0"---30H
	"2"---32H		"2"---32H
	"0"---30H	Data of address 2104H	"0"---30H
	"3"---33H		"3"---33H
	"0"---30H		"0"---30H
	"4"---34H		"4"---34H
LRC CHECK	"E" ---45H	LRC CHECK	"E" ---45H
	"D" ---44H		"D" ---44H
END	CR ---0DH	END	CR ---0DH
	LF ---0AH		LF ---0AH

RTU mode:

Asking for information string format		Answering information string format	
Address	01H	Address	01H
Function code	08H	Function code	08H
content	01H	content	01H
	02H		02H
	03H		03H
	04H		04H
CRC CHECK Low	41H	CRC CHECK Low	41H
CRC CHECK High	04H	CRC CHECK High	04H

Check code:

ASCII mode : Double byte ASCII code

Calculation method:

For message sending end, the calculation of LRC is the method of continuous accumulation the byte from "slave address" to "running data" which is not converted to ASCII code, discarding carry-over, reversing the 8 bit data, then plus 1 (converting to complement), finally converted to ASCII code, putting into the checkout area, high byte in front, low byte in post. For The message receiving end, the same LRC method is used to calculating checksum of received data, and comparing it with the received checksum. If they are equal, the message received is correct. If not equal, the received message is wrong. If error, the message frame is discarded with no answering, while the end continuing to receive the next frame data.

RTU mode : two bytes of 16 hex

The CRC domain is two bytes, including a binary value of 16 bits. It is calculated and added to the message by the sending end; while low byte added in front, and high byte added in post then, so the high byte of CRC is the last of the message. The receiving device re-calculates the CRC of the message, and compares it with the CRC in receiving domain, if the two values are different, it means there is error in received message, and the message frame is discarded, while there is no responding but waiting for the next frame data. CRC checksum calculation method reference to MODBUS protocol specification.

Communication protocol parameter definition:

definition	Parameter address	Function description
Commands to inverter (06H)	2000H	0001H : RUN
		0002H : FWD
		0003H : REV
		0004H : JOG
		0005H : FWD JOG
		0006H : REV JOG
		0007H : DEC and STOP
		0008H : STOP
		0009H : JOG STOP
		000AH : RESET
	2001H	Freq. setting

definition	Parameter	Function description
Monitoring inverter (03H)	2100H	Read ERROR code
	2101H	State of inverter
		BIT0 : STOP sign , 0 : STOP ; 1 : RUN
		BIT1: Under voltage sign, 1: Under voltage ; 0 : Normal
		BIT2:FWD REV sign, 1 : REV ; 0 : FWD
		BIT3:JOG sign, 1 : JOG ; 0 : NON JOG
		BIT4:Close loop control , 1 : Close ; 0 : Non close
		BIT5: swing freq. sign , 1 : swing ; 0 : non swing
		BIT6:PLC run sign , 1 : PLC run , 0 : non PLC
		BIT7:terminal multi-stage speed , 1 : multi-stage 0 : non multi-stage
		BIT8:normal running , 1 : normal ; 0 : non
		BIT9:Freq. from comm. , 1 : yes ; 0 : no.
		BIT10:Freq. from analog input , 1 : yes ; 0 : no.
		BIT11:run commands from comm. , 1 : yes ; 0 : no.
BIT12: parameter password protection , 1 : yes ; 0 : no.		
	2102H	Read Freq. setting
	2103H	Read output Freq.
	2104H	Read output current
	2105H	Read bus voltage
	2106H	Read output voltage
	2107H	Read motor speed
	2108H	Read module temp.
	2109H	Read VI analog input
	210AH	Read CI analog input
	210BH	Read software version
	210CH	Read inverter terminal status
	210DH	Read set pressure
	210EH	Read feedback pressure

Definition	Parameter address	Function description
Read function code (03H)	GGnnH (Gg : function code number. nn :function code number)	Responding function code
Read function code (06H)	GGnnH (GG : function code number. nn :function code number)	Function code writing into inverter

Error code:

Error code	Description
01H	Function code error. it can not be identified : 03H · 06H · 08H
02H	Address error, it can not be identified
03H	Data error. Data overrun

